

Bolts
Crank
Clamps
Fasteners
Handles
Handwheels
Knobs
Levers
Leveling Pads
Nuts
Rings
Rod Ends
Tooling Balls
Washers
Workholding Tools



VALTRA

Standard Machine Parts & Tooling Components

PRODUCT CATALOG

Quality Made Affordable



It has been our privilege to serve you, our valued customers, these past 36 years. We thank you for your business, your friendship, and the open communication you've provided over the years. In working together, your feedback has directed our new product development, and helped us design a produce mix that best suits your needs, at a price that will help you stay on budget, and maximize your profits. It is always a pleasure to serve you, and we look forward to serving you for many years to come...



Corporate Headquarters



Manufacturing Facility

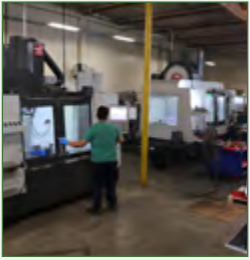

..... VALTRA

A Lean, Purpose-Driven Product Line that Delivers Value

With over 34 years of experience to draw upon, we've crafted a product line featuring the most popular, highest-volume machine parts and components, which we produce in volume for the industrial marketplace. Why is this important to you, the customer? Because it means we can concentrate on the most vital manufacturing issues, such as: quality, appearance, function, and value. By producing in volume, we can better control quality, and utilize the most efficient manufacturing practices for the best cost savings. Then we can pass those cost savings on to you, our valued customers.

Quality Made Affordable - Our Pledge to YOU.

The cost of doing business continues to increase. We feel it is our responsibility to help you control the costs of production by supplying you with standard machine parts and components that are economy-priced, yet quality-built. Our manufacturing team works cohesively to utilize the most lean, efficient manufacturing methods.

Mission Statement

This company was built with the goal of manufacturing products of the highest quality, at a competitive price, to help our customers control costs, so we may significantly contribute to their prosperity. We aim to grow with our customers by anticipating and responding promptly to their needs. It is our policy, and our tradition, to establish and nurture long-term partnership-relationships with our customers as their full service supplier. We accomplish this by continuously improving our quality, reliability and service, and maintaining a superior level of integrity in all business transactions. We believe that our employees are one of our most valuable resources. We provide opportunities for their growth and development through teamwork, communication, education, training, and safety. We strive to provide a secure and growth oriented work environment where the entire team enjoys the rewards of our success.



Tooling Component Manufacturers Association International



American Welding Society



Society of Manufacturing Engineers









Specialty Tools & Fasteners Distributors Association











TABLE OF CONTENTS







Standard Machine Parts

HANDWHEELS



 A1 Offset Square Rim Handles	1
 A3 Econo Handwheels	1
 A4 Stainless Steel Handwheels	2
 A7 A9 A10 Die Cast Handwheels	2
 A13 A23 Offset Handwheels	3
 A33 A43 Cast Iron Handwheels	3

HANDLES





 B1 Fixed Tapered Handles	4
 B2 Revolving Tapered Handles	4
 B4 Foldable Revolving Handles	4
 B5 B6 Revolving & Fixed Handles	5
 B7 Phenolic Revolving Handles	5
 B8 Stainless Steel Handles	5
 Ball Crank Handles	6
 C1 C4 Balanced Crank Handles	6
 C4 Stainless Steel Crank Handles	7
 C7 Aluminum Crank Handles	7
 C9 Stainless Steel Crank Handles	8

 D1 Zinc Alloy Adjustable Handles	9
 D9 Speed Ball Handles	14
 D10 Euro Design Adjustable Handles	10
 D12 Plastic Adjustable Handles	11
 F1 Cabinet Handles	8
 F2 Cabinet "U" Handles	8

LEVERS

 G Series Lever Bars	12
 D4 Steel Clamp Levers	13
 D7 Clamping Levers	13

KNOBS

 Thermoplastic Knurled Knobs	14
 K2 Phenolic Ball Knobs	14
 Cast Iron Hand Knobs	15
 Quick Acting Hand Knobs	15
 K82 Stainless Steel Hand Knobs	16





Famous Brand Milling Replacement Parts	39
---	-----------

Tooling Components







TOOLING BALLS

 Standard Tooling Balls	17
 Shoulder Tooling Balls	17
 Toolmaker's Construction Balls	17

BOLTS

 T-Bolts	18
 T-Slot Bolts	19
 Rotary T-Bolts	19
 Channel T-Bolts	20
 T-Strap Bolts	20



EYE BOLTS / ROD ENDS

 Lifting Eye Bolts	21
 Jig Latch Bolts	21
 Swing Bolts	21
 Plain Eye Bolts / Rod Ends	22
 Stainless Steel Eye Bolts / Rod Ends	23
 Blank Rod Ends	23





SOCKET SHOULDER SCREW

 Socket Shoulder Screws	24
--	----



WASHERS

	C-Washers	25
	Swing C-Washers	25
	Spherical Washers	25







NUTS





	Check Nuts	26
	Flanged Nuts	26
	Swivel Nuts	26
	Rotary T-Nuts	27
	T-Slot Nuts	27

HOIST RINGS

	Safety Hoist Rings	28
	Heavy Duty Hoist Rings	29

LOCATING COMPONENTS



	Rest Buttons	31
	Bullet Nose Pins Liners	31
	Bullet Nose Round Pins	31
	Bullet Nose Relieved Pins	31
	Bullet Nose Dowels	32
	Bullet Nose Liners	32

	Headless Retainers	32
	Shoulder Retainers	32
	Round Pins	32
	Diamond Pins	32







LEVELING PADS

	Steel & Stainless Steel Leveling Pads	33
	Plastic Leveling Pads	33
	Plastic Leveling Pads with Lag Holes	34
	Heavy Duty Fixed Glides	34

SPRING LOADED DEVICES

	Round Nose Spring Stops	35
	Square Nose Spring Stops	35

CLAMPS

	Hook Clamp Assemblies	35
	Forged Adjusta-Clamps	36
	Cam Action Clamps	37
	Double Cams	37
	Bedding Support	38
	Upthrust Clamps	38

Custom Machine Parts and Components

When an off-the-shelf part won't fill your needs, we're ready to help. Just send us a drawing of the machine part, component, or fastener that meets your requirements. We'll work with you to manufacture the product(s) that ideally suits your application, and your budget. Or we'll modify one of our standard items to your exact specifications. Call or e-mail our Engineering Team with details of your project.

Capabilities

- Broaching
- Casting
- Centerless Grinding
- CNC Milling
- CNC Turning
- Forging
- Honing
- OD Grinding
- Stamping
- Thread Rolling
- Wire EDM

Phone

800.989.5244

E-Mail

sales@valtrainc.com

Standard Machine Parts

HANDWHEELS

A1 Offset Square Rim Handwheels

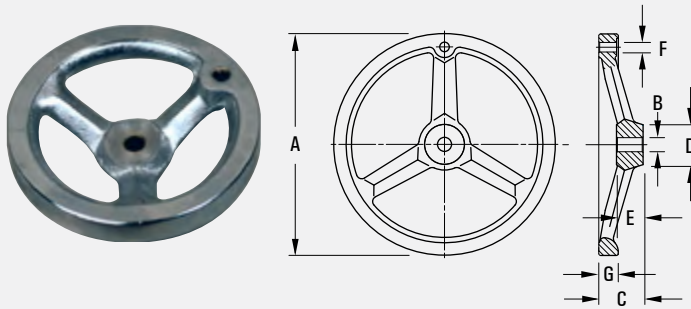

Material Cast Iron
Finish Bright Chrome Plated

- This high-quality cast iron hand wheel is bright chrome finished. The wheel is engineered with three offset spokes, and has a square outside rim to enhance the appearance.
- Two versions: one with threaded hole for the handles, one without.

See Page 4 for information about B1 & B2 handwheels.

Handwheel Without Handle

Part No.	A	B	C	D	E	F	G
A1-4AC	4"	3/8	1-1/4	7/8	3/4	1/4-20	9/16
A1-5AC	5"	3/8	1-7/16	1-1/8	3/4	5/16-18	5/8
A1-6AC	6"	1/2	1-9/16	1-1/4	13/16	3/8-16	3/4
A1-8AC	8"	5/8	1-3/4	1-7/16	1"	3/8-16	25/32
A1-10AC	10"	5/8	2"	1-3/4	1-3/16	1/2-13	7/8

Handwheel With Handle

Part No.	Fixed	Revolving	Handle Length
A1-4F	B1-28		2"
A1-4R		B2-28	
A1-5F	B1-33		2-1/2
A1-5R		B2-33	
A1-6F	B1-39		3-1/4
A1-6R		B2-39	
A1-8F	B1-39		
A1-8R		B2-39	4"
A1-10F	B1-53		
A1-10R		B2-53	

A3 Econo Handwheels

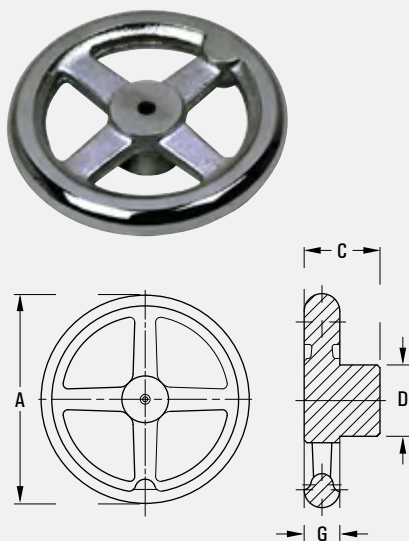

Material Cast Iron
Finish Chrome Plated

- An economical, yet well-made hand wheel. Comes with round machined rim. Polished and chrome plated.
- The hub has 1/8" center drilled for easy modification. All unmachined surfaces are tumbled smooth.

Part No.	A	C	D	G
A3-3	3"	1-1/16	1"	17/32
A3-4	4"	1-1/8	1-1/4	11/16
A3-5	5"	1-1/8	1-1/4	23/32
A3-6	6"	1-1/4	1-5/8	3/4
A3-8	8"	1-3/8	1-7/8	7/8
A3-10	10"	2-1/4	2-1/4	1"

A4 Stainless Steel Handwheels



Material 304 Stainless Steel
Finish Machined

- The dish type handwheel comes with a stainless steel revolving handle. Stainless steel handwheel comes with center drill hole.
- The wheel and handle are completely machined giving it a nice smooth finish.
- To order the handwheel only without the handle, remove the "R" suffix in the Part No.

See Page 5 for information about B8 Stainless Steel Revolving Handles.

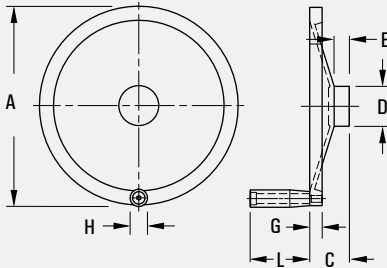

Part No.	A	C	D	E	G	H	L
A4-3SR	3"	1.1	0.87	0.475	0.24	0.39	1.49
A4-4SR	4"	1.25	1.02	0.475	0.31	0.47	1.57
A4-6SR	6"	1.5	1.50	0.475	0.50	0.75	2.50
A4-8SR	8"	1.8	1.80	0.625	0.56	0.87	3.00
A4-10SR	10"	2.0	2.00	0.75	0.62	0.87	3.00

A7, A9, A10 Die Cast Handwheels



Material Aluminum Die Cast
Finish Black Powder Coated

- This family of handwheels are made of aluminum die casting, and are available with or without a revolving handle, or with foldable-revolving handle.
- Handle can be folded down by pulling handle out. Simply push toward the center of the wheel. To engage the handle for cranking, pull and it will automatically snap into position.

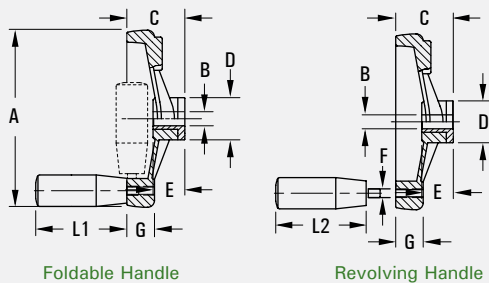

Foldable Handle

Revolving Handle

Part No.			A	B reamed	C	D	E	F	G	L1	L2
Foldable Handle	Revolving Handle	Without Handle									
A7-4	A9-4	A10-4	4.0	3/8	1-5/8	1-1/8	0.67	1/4-20	3/4	2.19	1.96
A7-5	A9-5	A10-5	5.0	3/8	1-3/4	1-1/4	0.70	5/16-18	7/8	2.50	2.49
A7-6	A9-6	A10-6	6.0	1/2	1-7/8	1-1/2	0.80	3/8-16	1"	3.15	3.24
		A10-6-SB	6.0	5/8	2-1/16	1-1/2	1.13	5/16-18	1"		
A7-8	A9-8	A10-8	8.0	5/8	2-1/8	1-7/8	1.00	3/8-16	1-1/8	3.15	3.24

Standard Machine Parts

HANDWHEELS

A13, A23 Offset Handwheels

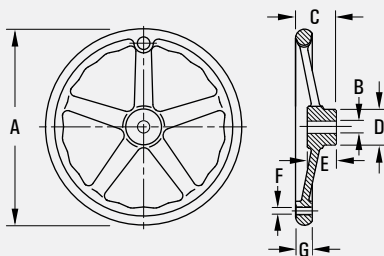

Handwheel with Fixed Handle

Part No.	
Chrome	Fixed
A23-3F	B5-19
A23-4F	B5-19
A23-5F	B5-25
A23-6F	B5-31
A23-8F	B5-37
A23-10F	B5-37
A23-12F	B5-50

Handwheel with Revolving Handle

Part No.	
Chrome	Revolving
A23-3R	B6-19
A23-4R	B6-19
A23-5R	B6-25
A23-6R	B6-31
A23-8R	B6-37
A23-10R	B6-37
A23-12R	B6-50

Material Cast Iron
Finish Tumbled and Plain (A13)
Chrome Plated (A23)

- Modern, and yet surprisingly affordable hand-wheel comes with round machined rim, and two different finishes to fit your budget.
- A13 is cast, tumbled clean and smooth, without holes. A23 is polished, chrome-plated and ready to use, and the wheel is tapped and ready for the handle.
- 8" size and larger comes with wavy inside rim for better gripping.
- Dimensions for A-13 may be slightly larger than the finished sizes as shown in the table.
- 3" - 8" diameter has three spokes, 10" - 16" diameter has five spokes.

See Page 5 for information about B5 and B6 handles.

Handwheel Without Handle

Part No.		A	B	C	D	E	F	G
Plain	Chrome							
A13-3	A23-3	3"	3/8	1-3/8	1"	1"	#10-24	1/2
A13-4	A23-4	4"	3/8	1-1/2	1-1/8	1-1/16	#10-24	9/16
A13-5	A23-5	5"	3/8	1-5/8	1-1/4	1-3/16	1/4-20	19/32
A13-6	A23-6	6"	1/2	1-13/16	1-3/8	1-1/4	5/16-18	21/32
A13-8	A23-8	8"	5/8	2-3/16	1-21/32	1-1/2	3/8-16	7/8
A13-10	A23-10	10"	5/8	2-3/8	1-7/8	1-21/32	3/8-16	15/16
A13-12	A23-12	12"	3/4	2-1/2	2-5/32	1-25/32	1/2-13	1"

A33 A43 Cast Iron Handwheels

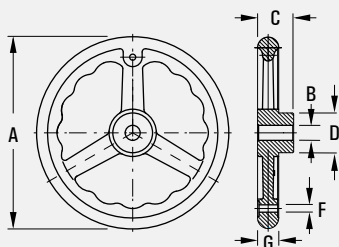
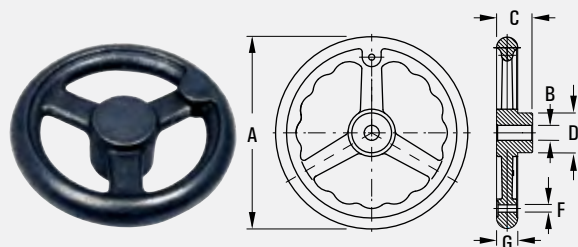

Handwheel with Fixed Handle

Part No.	
Chrome	Fixed
A43-3F	B5-19
A43-4F	B5-19
A43-5F	B5-25
A43-6F	B5-31
A43-8F	B5-37

Handwheel with Revolving Handle

Part No.	
Chrome	Revolving
A43-3R	B6-19
A43-4R	B6-19
A43-5R	B6-25
A43-6R	B6-31
A43-8R	B6-37

Material Cast Iron
Finish Tumbled and Plain (A33)
Chromed Plated (A43)

- Straight spokes design.
- 8" size and larger comes with wavy inside rim for better grip
- 3" - 8" diameter has three spokes, 10" - 12" diameter has five spokes.

See Page 5 for information about B5 & B6 handles.

Handwheel Without Handle

Part No.		A	B	C	D	F	G
Plain	Chrome						
A33-3	A43-3	3"	3/8	1"	1"	#10-24	1/2
A33-4	A43-4	4"	3/8	1-1/16	1-1/8	#10-24	9/16
A33-5	A43-5	5"	3/8	1-3/16	1-1/4	1/4-20	19/32
A33-6	A43-6	6"	1/2	1-1/4	1-3/8	5/16-18	21/32
A33-8	A43-8	8"	5/8	1-1/2	1-21/32	3/8-16	7/8

B1 Fixed Tapered Handles

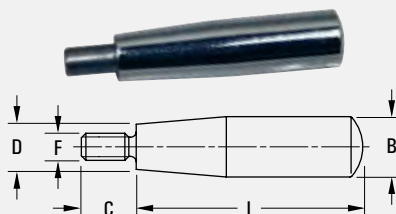

Metric Thread

Part No.	L	B	C	D	F
B1-M6S	2"	1/2	7/16	13/32	M6
B1-M8S	2-1/2	5/8	9/16	15/32	M8
B1-M10S	3-1/4	3/4	11/16	19/32	M10

Material Carbon Steel / Stainless Steel
Finish Chrome Plated

- Available with either a threaded or press-fit end.

Part No.		L	B	C	D	F	Press Fit Tolerance
Carbon	Stainless						
B1-20		1-9/16	27/64	3/8	5/16	#10-24	
B1-25		2"	1/2	7/16	13/32	1/4	+0.0014 / +.0007
B1-28	B1-28S	2"	1/2	7/16	13/32	1/4-20	
B1-31		2-1/2	5/8	9/16	15/32	5/16	+0.0014 / +.0007
B1-33	B1-33S	2-1/2	5/8	9/16	15/32	5/16-18	
B1-38		3-1/4	3/4	11/16	19/32	3/8	+0.0014 / +.0007
B1-39	B1-39S	3-1/4	3/4	11/16	19/32	3/8-16	
B1-50		4"	1"	13/16	23/32	1/2	
B1-53		4"	1"	13/16	23/32	1/2-13	+0.0016 / +.0009

B2 Revolving Tapered Handles

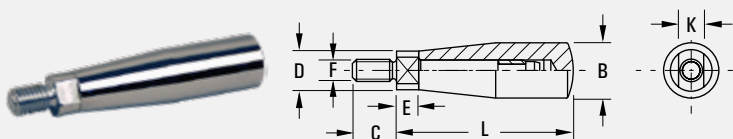

Metric Thread

Part No.	L	B	C	D	E	F	K
B2-M6S	2"	5/8	1/2	7/16	0.25	M6	5/16
B2-M8S	2-1/2	3/4	9/16	17/32	0.28	M8	3/8
B2-M10S	3-1/4	7/8	5/8	5/8	0.32	M10	7/16

Material Carbon Steel / Stainless Steel
Finish Chrome Plated

- Threaded end, carbon steel, chrome plated.

Part No.		L	B	C	D	E	F	K
Carbon	Stainless							
B2-28	B2-28S	2"	5/8	1/2	15/32	0.25	1/4-20	5/16
B2-33	B2-33S	2-1/2	3/4	9/16	9/16	0.28	5/16-18	3/8
B2-39	B2-39S	3-1/4	7/8	5/8	5/8	0.32	3/8-16	7/16
B2-53		4"	1"	3/4	23/32	0.39	1/2-13	5/8

B4 Foldable Revolving Handles

Material Handle - Thermoplastic
 Hardware - Carbon Steel / Stainless Steel
Finish Black

- This handle can be folded away as required. To change from the vertical to horizontal position, pull the spring loaded handle out and fold away.
- The handle comes in two forms, with female and male threads.
- Female thread only - to prevent the head from turning, the head should be pinned down with a 3 mm roll pin (std. accessory).

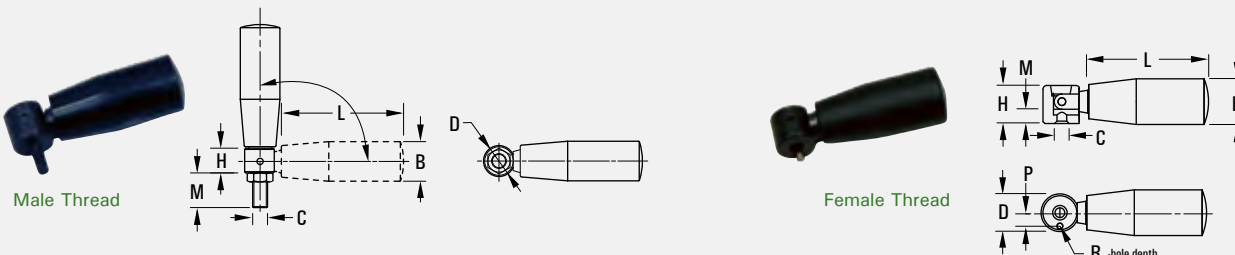

Male Thread

Part No.		L	B	C	D	H	M
Carbon	Stainless						
B4-2B	B4-2BS	2.00	7/8	1/4-20	0.630	1/2	5/8
B4-4B	B4-4BS	2.50	15/16	5/16-18	0.780	5/8	3/4
B4-6B	B4-6BS	3.15	1"	3/8-16	0.780	5/8	7/8

Female Thread

Part No.		L	B	C	D	H	M	P	R
Carbon	Stainless								
B4-2A	B4-2A-SS	2.00	7/8	#10-24	0.630	5/8	5/32	0.197	0.158
B4-4A	B4-4A-SS	2.50	15/16	1/4-20	0.780	25/32	7/32	0.276	0.197
B4-6A	B4-6A-SS	3.15	1"	1/4-20	0.780	25/32	7/32	0.276	0.197

Standard Machine Parts

HANDLES

B5, B6 Revolving & Fixed Handles

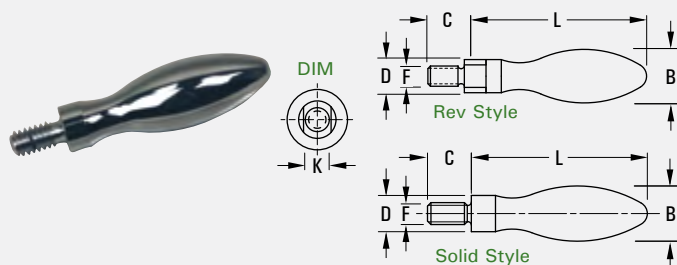

Metric Thread

Part No.		F	B	C	D	L	K
Carbon	Stainless						
B5-M6	B5-M6S	M6	5/8	1/2	0.44	2"	
B6-M6	B6-M6S					2-1/4	5/16
B5-M8	B5-M8S	M8	13/16	9/16	0.53	2-5/8	
B6-M8	B6-M8S					2-13/16	3/8
B5-M10	B5-M10S	M10	1"	5/8	0.63	3-3/16	
B6-M10	B6-M10S					3-3/8	7/16
B5-M12	B5-M12S	M12	1-1/4	3/4	0.75	3-3/4	
B6-M12	B6-M12S					4"	5/8

Material Medium Carbon Steel / Stainless Steel
Finish Machined

- The fixed (B5) and revolving (B6) steel handles are polished and bright chrome-plated to enhance the appearance.
- A modern design with a comfortable grip.

Part No.		F	B	C	D	L	K
Carbon	Stainless						
B5-19		#10-24	1/2	3/8	0.32	1-11/16	
B6-19			5/8		0.40	1-7/8	1/4
B5-25	B5-25S	1/4-20	5/8	1/2	0.44	2"	
B6-25	B6-25S					2-1/4	5/16
B5-31	B5-31S	5/16-18	13/16	9/16	0.53	2-5/8	
B6-31	B6-31S					2-13/16	3/8
B5-37	B5-37S	3/8-16	1"	0.69	0.63	3-3/16	
B6-37	B6-37S			5/8		3-3/8	7/16
B5-50	B5-50S	1/2-13	1-1/4	0.81	0.75	3-3/4	
B6-50	B6-50S			3/4		4"	5/8

B7 Phenolic Revolving Handles

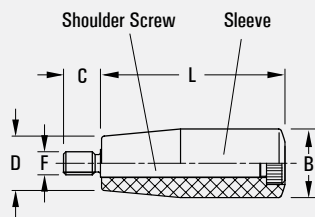

Material Handle - Phenolic
Shoulder Screw - Steel
Finish Machined

- Revolving black phenolic handle on a socket head shoulder screw.
- The most economical revolving handle available.

Part No.	L	B	C	D	F
B7-10	0.93	0.56	0.38	0.41	#10-24
B7-15	1.21	0.70	0.44	0.55	1/4-20
B7-20	1.96	0.85	0.44	0.67	1/4-20
B7-25	2.49	0.93	0.50	0.73	5/16-18
B7-35	3.24	1.12	0.50	0.88	5/16-18
B7-40	3.24	1.12	0.625	0.88	3/8-16

B8 Stainless Steel Revolving Handles

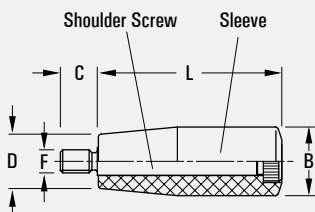

Material 300 Stainless Steel
Finish Machined

- Revolving stainless steel handle comes with stainless steel shoulder screw.
- The handle is completely machined giving it a nice smooth finish.

See Page 2 for information about A4 stainless steel handwheels.

Part No.	L	B	C	D	F
B8-30R	1.50	0.39	0.24	0.32	#10-32
B8-40R	1.57	0.47	0.31	0.39	1/4-20
B8-60R	2.50	0.75	0.39	0.63	5/16-18
B8-80R	2.98	0.87	0.50	0.71	3/8-16
B8-100R	3.00	0.87	0.63	0.71	3/8-16

Ball Crank Handles

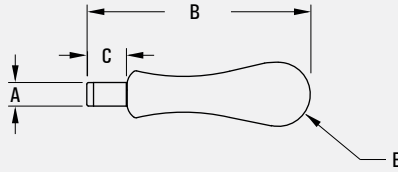

Material Carbon Steel
Finish Unfinished

- These handles are polished to a smooth finish.
- Ergonomic design.

Solid Handle - Press Fit

Part No.	A +0.002 / +0.001	B	C	E
645205	1/4	1-23/32	7/16	7/16
645210	5/16	2-5/32	7/16	7/16
645215	3/8	2-11/32	9/16	9/16
645220	7/16	3-29/32	11/16	11/16
645225	1/2	5"	15/16	15/16

Solid Handle - Threaded Shank

Part No.	A	B	C	E
645275	1/4-20	1-23/32	7/16	7/16
645280	5/16-18	2-5/32	7/16	3/4
645285	3/8-16	2-11/32	9/16	7/8
645290	7/16-14	3-29/32	11/16	1-3/16
645295	1/2-13	5"	15/16	1-3/8

Revolving Handle - Press Fit

Part No.	A +0.002 / +0.001	B	C	E
645250	5/16	2-5/8	9/16	7/8
645255	3/8	3-25/32	3/4	1-1/8
645260	7/16	4-1/32	3/4	1-3/16
645265	1/2	5-1/8	15/16	1-3/8

C1 Balanced Crank Handles

Material Carbon Steel / Stainless Steel
Finish Chrome Plated

- Fixed handle. Cross drilled on one wall.

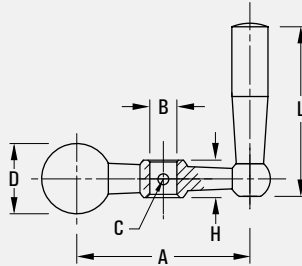

Part No.		A	B	C one wall	D	H	L
Carbon	Stainless						
C1-1C		2"	5/16	1/8	13/16	7/16	2"
C1-2C	C1-2S	2-1/2			1"	9/16	2-1/2
C1-3C	C1-3S	3-1/8	3/8	5/32	1-1/4	11/16	3-1/4
C1-4C	C1-4S	4"					
C1-5C	C1-5S	5"	1/2	3/16	1-1/2	7/8	4"
C1-6C		6-1/8					

C4 Balanced Crank Handles

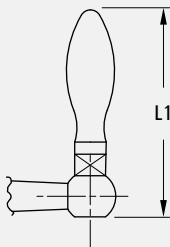

Revolving



Material Carbon Steel
Finish Bright Chrome Plated

- Modern steel balanced crank handles come either with a revolving or fixed handle, and are balanced at the center.
- Center hole is cross-drilled on one wall.

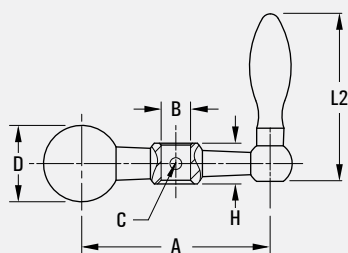

Fixed

Part No.		A	B	C one wall	D	H	L1	L2	Keyway
Revolving	Fixed								
C4-10A	C4-10B	2"	5/16	1/8	13/16	7/16	2-5/16	2-1/8	
C4-20A	C4-20B	2-1/2			1"	9/16	2-3/4	2-9/16	
C4-30A	C4-30B	3-1/8	3/8	5/32	1-1/4	11/16	3-1/2	3-1/4	
C4-40A	C4-40B	4"							
C4-50A	C4-50B	5"	1/2	3/16	1-1/2	7/8	4-3/16	3-15/16	
C4-56A	C4-56B	5"	5/8				1/8W x 1/16L		
C4-60A	C4-60B	6-1/8	1/2				4-1/4	4-1/16	

Standard Machine Parts

HANDLES

C4 Stainless Steel Crank Handles

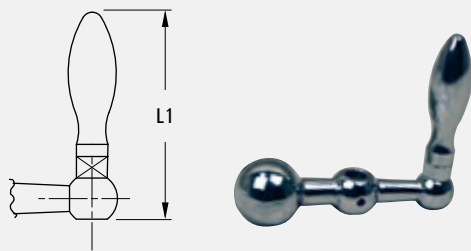

Revolving

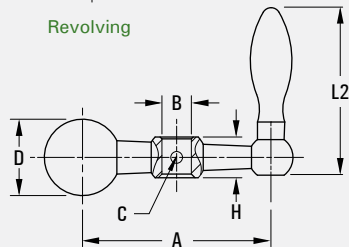

Fixed

Material 304 Stainless Steel
Finish Plain

- Stainless steel balanced crank handles come with a fixed handle, and are balanced at the center.
- Center hole is cross-drilled on one wall.

Part No.		A	B	C	D	H	L1	L2	Keyway
Revolving	Fixed			one wall					
C4-20AS	C4-20BS	2-1/2	5/16	1/8	1"	9/16	2-3/4	2-9/16	
C4-30AS	C4-30BS	3-1/8	3/8	5/32	1-1/4	11/16	3-1/2	3-1/4	
C4-40AS	C4-40BS	4"							
C4-50AS	C4-50BS	5"	1/2	3/16	1-1/2	7/8	4-3/16	3-15/16	
C4-55AS	C4-55BS	5"	5/8						1/8W x 1/16L

C7 Crank Handles



Material Body - Aluminum Die Cast
Handle - Plastic
Finish Black Painted

- Available with black plastic revolving or folding handles.
- Choose from bored round hole or broached square hole.

Aluminum Crank Handle with Plastic Revolving Handle

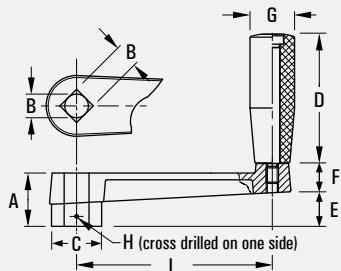

Crank Handle with Revolving Handle

Bored Round Hole	Broached Square Hole	A	L	B	C	D	G	E	F	H
C7-12	C7-12B	0.68	1.20	5/16	0.55	0.94	0.56	0.34	0.37	..
C7-25	C7-25B	0.79	2.52	3/8	0.75	1.22	0.70	0.43	0.47	1/16
C7-32	C7-32B	0.95	3.15	3/8	0.91	1.97	0.85	0.55	0.55	1/16
C7-40	C7-40B	1.10	3.94	1/2	1.06	2.50	0.93	0.67	0.59	3/32
C7-50	C7-50B	1.34	4.92	5/8	1.26	3.25	1.12	0.87	0.71	3/32
C7-63	C7-63B	1.50	6.30	3/4	1.38	3.25	1.12	1.02	0.71	3/32

See Page 5 for information about B7 revolving handles.

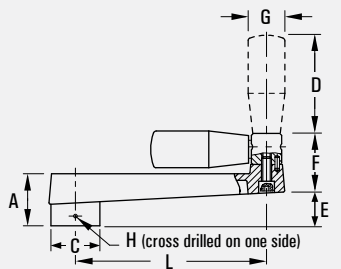

Crank Handle with Foldable Revolving Handle

Aluminum Crank Handle with Plastic Foldable Revolving Handle.

C7-40F	C7-40BF	1.10	3.94	1/2	1.06	2.00	0.88	0.67	1.22	3/32
C7-50F	C7-50BF	1.34	4.92	5/8	1.26	2.50	0.94	0.87	1.49	3/32
C7-63F	C7-63BF	1.50	6.30	3/4	1.38	3.15	1.00	1.02	1.49	3/32

See Page 4 for information about B4 foldable handles.

C9 Stainless Steel Crank Handles

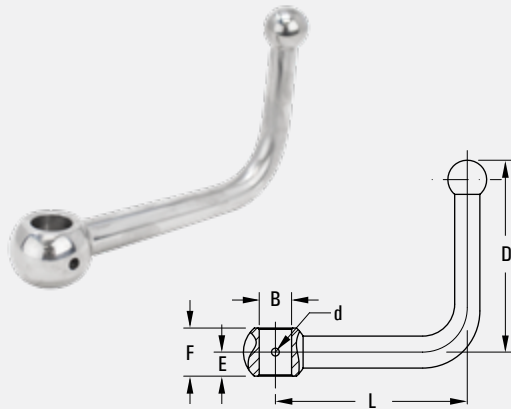

Material 300 Stainless Steel
Finish Machined

- One piece construction, no seams to trap dirt or contaminants.
- Highly polished finish assures a comfortable grip and smooth crank.
- Can be used as a crank handle or as a trigger lever.
- Ideal use for the food and chemical industry.

Part No.	B	L	D	E	F	d one wall
C9-30S	1/2	3"	3"	3/8	3/4	1/8
C9-45S	5/8	4-1/2	3-1/2	7/16	7/8	3/16

F1 Cabinet Handles

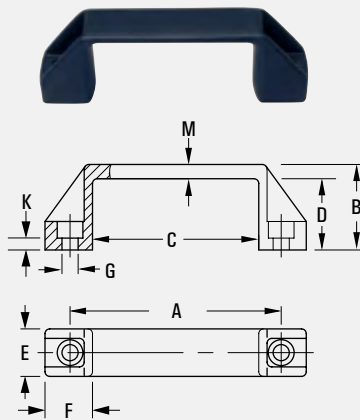

Material Aluminum Die Cast
Finish Black Painted

- This rectangular shaped handle allows easy front mounting.
- Use socket head cap screws or slotted fillister head screws.

Part No.	A	B	C	D	E	F	G	K	M
F1-2	3.50	1.42	2.76	1.18	0.79	0.79	1/4	0.20	0.24
F1-4	4.75	1.58	3.78	1.30	1.02	0.87	5/16	0.24	0.28
F1-6	7.00	1.97	6.22	1.65	1.10	0.83	5/16	0.35	0.32

F2 Cabinet "U" Handles

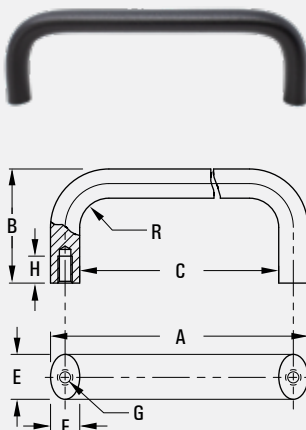

Material Aluminum Die Cast
Finish Black Painted

- This handle is machined, polished, and painted.
- Black is the stock color, with red and silver as special order.

Part No.	A	B	C	E	F	G x H	R
F2-2	4.50	2.00	4.00	0.79	0.51	1/4-20 x 0.47	0.51
F2-4	6.00		5.50				
F2-6	8.00		7.50				

Standard Machine Parts

HANDLES

D1 Zinc Alloy Adjustable Handles



Tapped Type

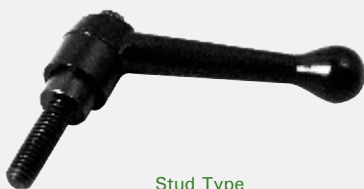

Stud Type

Material Zinc Alloy
Finish Black

- This zinc alloy handle can be rotated to the desired position. When handle is lifted, the teeth are disengaged for re-positioning. Release of the handle will re-engage the teeth for tightening or loosening action.
- Easily repositioned out of the way to a convenient position for maximum leverage.
- Choice of five handle sizes, tapped or stud type.

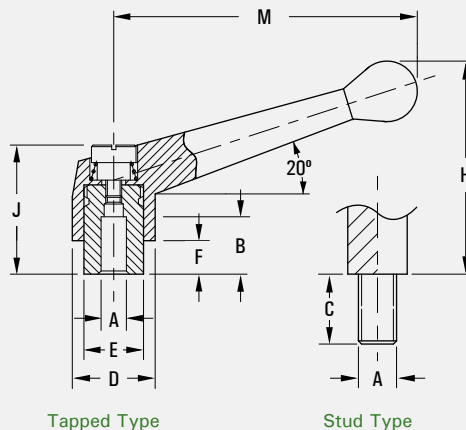

Tapped Type

Stud Type

Tapped Type

Part No.	A	B
D1-A10	1/8 Ream	5/16
D1-A11	#10-24	
D1-A12	1/4-20	
D1-A1-M6	M6	
D1-A20	1/8 Ream	7/16
D1-A21	1/4-20	
D1-A22	5/16-18	
D1-A2-M8	M8	
D1-A30	1/4 Ream	1/2
D1-A31	5/16-18	
D1-A32	3/8-16	
D1-A3-M10	M10	
D1-A40	5/16 Ream	5/8
D1-A41	3/8-16	
D1-A42	1/2-13	
D1-A4-M12	M12	
D1-A50	3/8 Ream	7/8
D1-A51	1/2-13	
D1-A52	5/8-11	
D1-A5-M16	M16	

Stud Type

Part No.	A	C
D1-B12	1/4-20	1/2
D1-B14		3/4
D1-B16		1"
D1-B18		1-1/2
D1-B1-M6	M6	max 1-1/2 *
D1-B22	5/16-18	3/4
D1-B24		1"
D1-B26		1-1/2
D1-B28		2"
D1-B2-M8	M8	max 2" *
D1-B32	3/8-16	3/4
D1-B34		1"
D1-B36		1-1/2
D1-B38		2"
D1-B3-M10	M10	max 2" *
D1-B42	1/2-13	1"
D1-B44		1-1/2
D1-B46		2"
D1-B48		2-1/2
D1-B4-M12	M12	max 3" *
D1-B52	5/8-11	1-1/2
D1-B54		2"
D1-B56		2-1/2
D1-B58		3"
D1-B5-M16	M16	max 3" *

* Cut threaded stud to suit your application

D	E	F	H	J	M
17/32	25/64	5/32	1-15/16	31/32	1-19/32
3/4	17/32	1/4	1-13/16	1-1/8	2-9/16
7/8	5/8	13/32	2-5/16	1-1/2	3-1/8
1"	3/4	13/32	2-5/8	1-11/16	3-3/4
1-1/4	29/32	15/32	3-1/8	2"	4-5/16

D10 European Design Adjustable Handle



Tapped Type



Stud Type

Material Zinc Alloy
Finish Black (D10)
 Chrome Plated (D10C)

- This zinc alloy handle can be rotated to the desired position. When handle is lifted, the teeth are disengaged for re-positioning. Release of the handle will re-engage the teeth for tightening or loosening action.
- Easily repositioned out of the way to a convenient position for maximum leverage.
- Choice of five handle sizes, tapped or stud type.

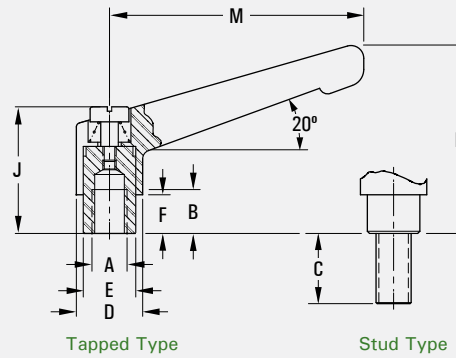

Tapped Type

Stud Type

Tapped Type

Part No.		A	B
Black	Bright Chrome		
D10-A10	D10C-A10	1/8 Ream	5/16
D10-A11	D10C-A11	#10-24	
D10-A12	D10C-A12	1/4-20	
D10-A1M6	D10C-A1M6	M6	
D10-A20	D10C-A20	1/8 Ream	7/16
D10-A21	D10C-A21	1/4-20	
D10-A22	D10C-A22	5/16-18	
D10-A2M8	D10C-A2M8	M8	
D10-A30	D10C-A30	1/4 Ream	1/2
D10-A31	D10C-A31	5/16-18	
D10-A32	D10C-A32	3/8-16	
D10-A3M10	D10C-A3M10	M10	
D10-A40	D10C-A40	5/16 Ream	
D10-A41	D10C-A41	3/8-16	
D10-A42	D10C-A42	1/2-13	
D10-A4M12	D10C-A4M12	M12	
D10-A50	D10C-A50	3/8 Ream	7/8
D10-A51	D10C-A51	1/2-13	
D10-A52	D10C-A52	5/8-11	
D10-A5M16	D10C-A5M16	M16	

Stud Type

Part No.		A	C
Black	Bright Chrome		
D10-B12	D10C-B12	1/4-20	1/2
D10-B14	D10C-B14		3/4
D10-B16	D10C-B16		1"
D10-B18	D10C-B18		1-1/2
D10-B1-M6	D10C-B1-M6	M6	max 1-1/2 *
D10-B22	D10C-B22	5/16-18	3/4
D10-B24	D10C-B24		1"
D10-B26	D10C-B26		1-1/2
D10-B28	D10C-B28		2"
D10-B2-M8	D10C-B2-M8	M8	max 2" *
D10-B32	D10C-B32	3/8-16	3/4
D10-B34	D10C-B34		1"
D10-B36	D10C-B36		1-1/2
D10-B38	D10C-B38		2"
D10-B3-M10	D10C-B3-M10	M10	max 2" *
D10-B42	D10C-B42	1/2-13	1"
D10-B44	D10C-B44		1-1/2
D10-B46	D10C-B46		2
D10-B48	D10C-B48		2-1/2
D10-B4-M12	D10C-B4-M12	M12	max 3" *
D10-B52	D10C-B52	5/8-11	1-1/2
D10-B54	D10C-B54		2"
D10-B56	D10C-B56		2-1/2
D10-B58	D10C-B58		3"
D10-B5-M16	D10C-B5-M16	M16	max 3" *

* Please specify length.

D	E	F	H	J	M
33/64	25/64	5/32	1-3/8	31/32	1-3/4
45/64	17/32	19/64	1-53/64	1-7/32	2-7/16
53/64	5/8	25/64	2-13/64	1-33/64	3-1/32
15/16	3/4	13/32	2-1/2	1-43/64	3-37/64
1-3/16	29/32	7/16	3"	2"	4-11/64

Standard Machine Parts

HANDLES

D12 Adjustable Plastic Handles

Double Gear Design. 30% stronger than the major European Design!

Material Handle - High Impact Glass Filled Nylon
Insert - Threaded Steel

Finish Black

- Versatile and lightweight, designed for lighter applications.
- Smooth action in releasing/engaging movements. When handle is lifted, the teeth are disengaged for re-positioning. Release of the handle will re-engage the teeth for tightening or loosening action.

See Page 9 for information about D1 Zinc die casted adjustable handles.

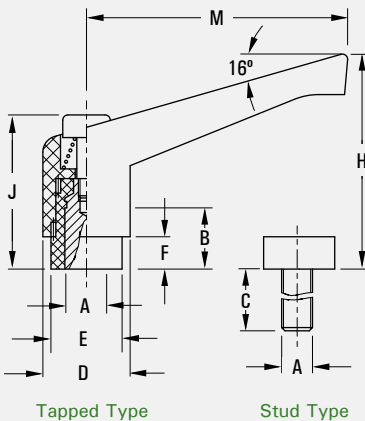

Tapped Type (Inch)

Part No.	A	B	D	E	F	H	J	M
D12-0A	Blank							
D12-0A1	#10-24	5/16	45/64	0.55	0.24	1.5	1.14	1.65
D12-0A2	1/4-20							
D12-1A	Blank							
D12-1A1	#10-24	5/16	23/32	0.55	0.24	1.6	1.14	2.00
D12-1A2	1/4-20							
D12-2A	Blank							
D12-2A2	1/4-20	1/2	7/8	0.69	0.32	2.1	1.50	2.50
D12-2A3	5/16-18							
D12-3A	Blank							
D12-3A3	5/16-18	11/16	1-1/16	0.87	0.39	2.6	1.88	3.19
D12-3A4	3/8-16							

Tapped Type (Metric Thread)

Part No.	A
D12-0AM5	M5
D12-0AM6	M6
D12-1AM5	M5
D12-1AM6	M6
D12-2AM6	M6
D12-2AM8	M8
D12-3AM8	M8
D12-3AM10	M10

Stud Type (Inch)

Part No.	A	C	D	E	F	H	J	M
D12-0B107	#10-24	3/4						
D12-0B205	1/4-20	1/2	45/64	0.55	0.24	1.5	1.14	1.65
D12-0B207		3/4						
D12-0B210		1"						
D12-0B215		1-1/2						
D12-1B107	#10-24	3/4						
D12-1B205	1/4-20	1/2	23/32	0.55	0.24	1.6	1.14	2.00
D12-1B207		3/4						
D12-1B210		1"						
D12-1B215		1-1/2						
D12-2B305		1/2						
D12-2B307	3/4							
D12-2B310	1"							
D12-2B312	1-1/4							
D12-2B315	1-1/2							
D12-2B320	2"							
D12-2B325	2-1/2							
D12-3B407	3/4	1-1/16	0.87	0.39	2.6	1.88	3.19	
D12-3B410	1"							
D12-3B412	1-1/4							
D12-3B415	1-1/2							
D12-3B420	2"							
D12-3B425	2-1/2							

Stud Type (Metric Thread)

Part No.	A
D12-0BM605	M6
D12-0BM607	
D12-0BM610	
D12-0BM615	
D12-1BM605	M6
D12-1BM607	
D12-1BM610	
D12-1BM615	
D12-2BM805	
D12-2BM807	
D12-2BM810	
D12-2BM812	
D12-2BM815	
D12-2BM820	
D12-2BM825	
D12-3BM1007	M10
D12-3BM1010	
D12-3BM1012	
D12-3BM1015	
D12-3BM1020	
D12-3BM1025	

G Series Lever Bars

Material Carbon Steel
Finish Bright Chrome Plated, 300 Series Stainless Steel

- Black Oxide model available, add B suffix. Ex: G2531-16-B
 - Phenolic knobs are standard. Plastic knobs available as options.
- See Page 9 for information about D1 Zinc die casted adjustable handles.

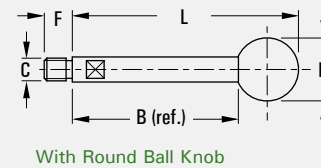
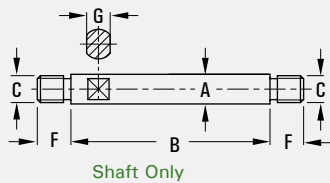

Shaft Only

Part No.		A	B	C	F	G
Chrome	Stainless					
G2531-16		0.31	1.6	1/4-20	3/8	1/4
G2531-18			1.8			
G2531-24			2.4			
G2531-33			3.3			
G2531-45			4.5			
G3139-15	G3139-15S	0.39	1.5	5/16-18	7/16	5/16
G3139-22	G3139-22S		2.2			
G3139-30	G3139-30S		3.0			
G3139-40	G3139-40S		4.0			
G3139-55	G3139-55S		5.5			
G3747-20	G3747-20S	0.47	2.0	3/8-16	1/2	3/8
G3747-27	G3747-27S		2.7			
G3747-32			3.2			
G3747-37	G3747-37S		3.7			
G3747-47	G3747-47S		4.7			
G3747-60	G3747-60S	6.0				
G5055-37	G5055-37S	0.55	3.7	1/2-13	5/8	7/16
G5055-47	G5055-47S		4.7			
G5055-57	G5055-57S		5.7			
G5055-67	G5055-67S		6.7			
G5062-37		0.62	3.7	1/2-13	5/8	1/2
G5062-44			4.4			
G5062-64			6.4			
G5062-84			8.4			
G5062-110			11.0			

With Round Ball Knob

Part No.	L	D
G2631-16	2.3	3/4
G2631-18	2.4	
G2631-24	3.1	
G2631-33	4.0	
G2631-45	5.2	
G3239-15	2.4	1"
G3239-22	3.1	
G3239-30	3.9	
G3239-40	4.9	
G3239-55	6.4	
G3847-20	3.1	1-3/8
G3847-27	3.8	
G3847-32	4.3	
G3847-37	4.8	
G3847-47	5.8	
G3847-60	7.1	1-1/2
G5155-37	5.0	
G5155-47	6.0	
G5155-57	7.0	
G5155-67	8.0	
G5162-37	5.2	1-1/2
G5162-44	5.9	
G5162-64	7.9	
G5162-84	9.9	
G5162-110	12.9	

Standard Machine Parts

LEVERS

D4 Steel Clamp Levers

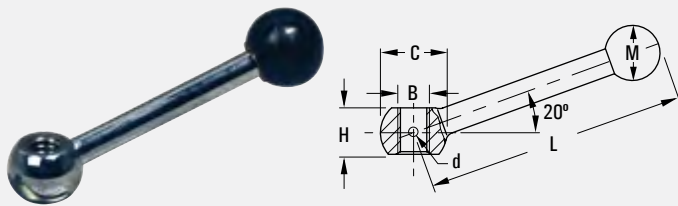

Material Carbon Steel
Finish Chrome Plated Except Ball Knob

- Versatile steel clamp handle/lever with many applications.
- The angled lever rods have a plastic ball on their ends for firm gripping. Comes in reamed hole or threaded hole.
- Polished and bright chrome plated for enhanced appearance.

Part No.	B	C	H	L	M	d one wall
D4-10A	1/4	5/8	7/16	2"	11/16	1/8
D4-15A	5/16-18					
D4-20A	5/16	25/32	9/16	2-1/2	3/4	1/8
D4-25A	3/8-16					
D4-30A	3/8	1"	3/4	3-1/4	1"	5/32
D4-35A	1/2-13					
D4-40A	1/2	1-1/4	7/8	4"	1-3/8	3/16
D4-45A	5/8-11					

D7 Clamping Levers

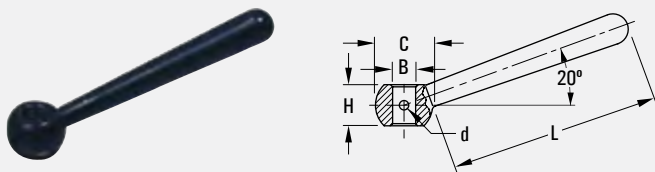

Material Carbon Steel / Stainless Steel
Finish Black Oxide

- Efficient and effective clamping lever with many applications.
- Features a one-piece construction with a highly polished finish.
- Polished and bright chrome plated for enhanced appearance.

Part No.		B	C	H	L	d one wall
Carbon	Stainless					
D7-10A	D7-10AS	1/4	5/8	7/16	2-11/16	1/8
D7-15A	D7-15AS	5/16-18				
D7-20A	D7-20AS	5/16	25/32	9/16	3-1/4	1/8
D7-25A	D7-25AS	3/8-16				
D7-30A	D7-30AS	3/8	1"	3/4	4-1/4	5/32
D7-35A	D7-35AS	1/2-13				
D7-40A	D7-40AS	1/2	1-1/4	7/8	5-3/8	3/16
D7-45A	D7-45AS	5/8-11				

D9 Speed Ball Handles

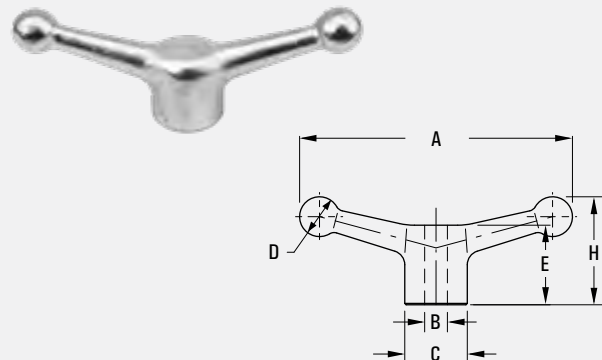

Material Malleable Iron
Finish Chrome Plated

- Balanced to permit rapid spinning.
- Available in blank, reamed or tapped hole.

Part No.	A	B	C	D	E	H
D9-500	4-7/8	Blank	1-1/8	3/4	1-5/8	2-1/4
D9-537		Ream 3/8				
D9-550		Ream 1/2				
D9-539		3/8-16				
D9-552		1/2-13				
D9-600	6"	Blank	1-3/8	7/8	1-3/4	2-3/8
D9-650		Ream 1/2				
D9-662		Ream 5/8				
D9-652		1/2-13				
D9-664		5/8-11				
D9-800	8"	Blank	1-3/4	1"	1-7/8	2-7/8
D9-862		Ream 5/8				
D9-875		Ream 3/4				
D9-864		5/8-11				
D9-877		3/4-10				
D9-895		1"-8				

Knurled Knobs

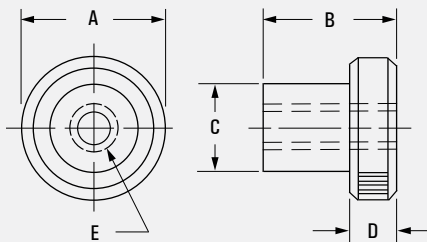

Material Mild Steel
Finish Black Oxide

- For adjusting and clamping applications.
- Large knurled head assures non-slip finger gripping.

Part No.	A	B	C	D	E
845005	3/4	5/8	7/16	1/4	10-24
845010	1"	3/4	5/8	1/4	1/4-20
845015	1-1/4	1-1/8	3/4	1/2	3/8-16
845020	1-1/2	1-1/4	1"	1/2	1/2-13

K2 Phenolic Knobs

Material Phenolic
Finish Black

K2 Ball Knob

- These classic ball knobs are made of phenolic, which has a smooth bright finish.
- Molded metal insert for easy assembly.
- Polished and bright chrome plated for enhanced appearance.

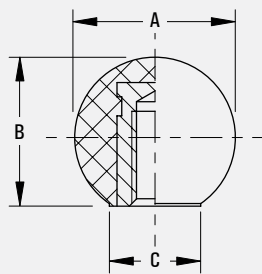

K2 Ball Knob

Part No.	A	B	C	Thread
K2-0610	11/16	19/32	3/8	10-32
K2-0611				10-24
K2-0725	3/4	47/64	1/2	1/4-20
K2-1025	1"	15/16	1/2	1/4-20
K2-1031				5/16-18
K2-1038				3/8-16
K2-1431	1-3/8	1-15/64	5/8	5/16-18
K2-1438				3/8-16
K2-1450				1-9/32
K2-1531	1-1/2	1-1/2	5/8	5/16-18
K2-1538				3/8-16

Standard Machine Parts

KNOBS

Quick Acting Knobs

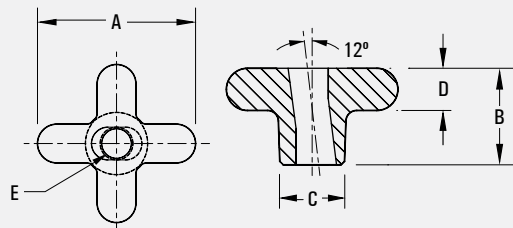

Material Cast Iron
Finish Chrome Plated

- Quick Acting Knobs are ideal for faster clamping. Tilt the knob and it will slide in or out. Straighten the knob and thread will engage, ready for placement.
- Comfortable, contoured shape.
- Face of knob is machined to ensure effective contact and proper engagement.

Part No.	A	B	C	D	E
845838	2"	1"	3/4	1/2	3/8-16
845950	2-1/2	1-1/8	1-1/8	1/2	1/2-13
845963	2-1/2	1-1/8	1-1/8	1/2	5/8-11

Cast Iron Hand knobs

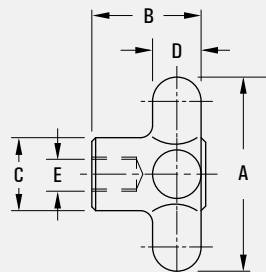

Tapped Type

Material Cast Iron
Finish Chrome

Blank, Tapped and Reamed Type

- This classic cast iron knob has a round contoured shape and a very comfortable grip.
- All knobs are tumbled smooth and chrome plated for corrosion resistance.

Part No.	A	B	C	D	E	L
845575	2"	1-1/8	3/4	1/2		
845590					3/8-16	0.7
845615	2-1/2	1-1/2	1-1/8	1/2		
845625					1/2-13	1.0
845635					5/8-11	1.0

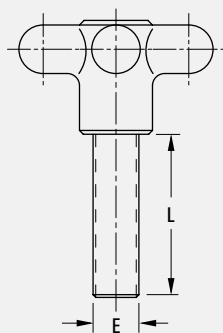

Stud Type

Stud Type

- This chrome plated cast iron knob comes with a black oxide finish screw.

Part No.	A	B	C	D	E	L
845710	2"	1-1/8	3/4	1/2	3/8-16	1.0
845715					3/8-16	1.5
845720					3/8-16	2.0
845750	2-1/2	1-1/2	1-1/8	1/2	1/2-13	1.5
845755					1/2-13	2.0
845760					1/2-13	2.5
845770					5/8-11	2.0
845775					5/8-11	2.5
845780					5/8-11	3.0

K82 Stainless Steel Hand knobs



Material 300 Stainless Steel
Finish Highly Polished

- Highly polished to a deep luster.
- Ideal for heavy duty applications.
- Drilled center hole for easy modifications.

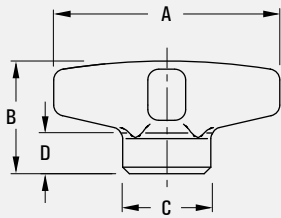

Blank

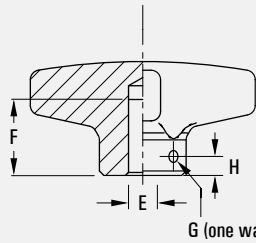

Reamed Blind

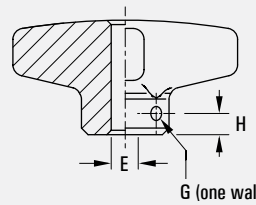

Reamed Thru

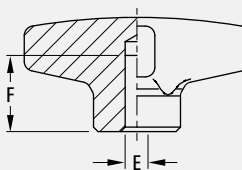

Tapped Blind

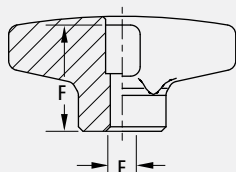

Tapped Thru

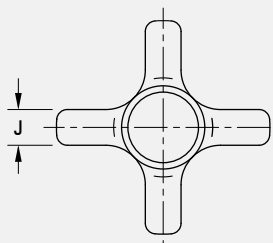

Part No.	A	B	C	D	E Hole Type	F Hole Depth	G Pin Hole	H	J
K82-2010	2.0	1.02	0.78	0.34	Blank				0.33
K82-2025					Rm 1/4	11/16 Blind	1/8	3/16	
K82-2026						Thru			
K82-2027					1/4-20	11/16 Blind			
K82-2028						1/2 Thru			
K82-2031					Rm 5/16	11/16 Blind	1/8	3/16	
K82-2032						Thru			
K82-2033					5/16-18	11/16 Blind			
K82-2034						5/8 Thru			
K82-2037					Rm 3/8	11/16 Blind	5/32	3/16	
K82-2038						Thru			
K82-2039					3/8-16	11/16 Blind			
K82-2040						3/4 Thru			
K82-3010					3.0	1.5	1.14	0.5	
K82-3037	Rm 3/8	1" Blind	5/32	1/4					
K82-3038		Thru							
K82-3039	3/8-16	1" Blind							
K82-3040		3/4 Thru							
K82-3050	Rm 1/2	1" Blind	3/16	1/4					
K82-3051		Thru							
K82-3052	1/2-13	1" Blind							
K82-3053		1" Thru							
K82-3062	Rm 5/8	1" Blind	1/4	1/4					
K82-3063		Thru							
K82-3064	5/8-11	1" Blind							
K82-3065		1-1/4 Thru							

Metric Thread

Part No.	A	B	C	D	E Hole Type	F Hole Depth	J
K82-2027M	2.0	1.02	0.78	0.34	M6	11/16 Blind	0.33
K82-2028M						1/2 Thru	
K82-2033M					M8	11/16 Blind	
K82-2034M						5/8 Thru	
K82-2039M	3.0	1.5	1.14	0.5	M10	11/16 Blind	0.47
K82-2040M						3/4 Thru	
K82-3039M					M10	1" Blind	
K82-3040M						1" Thru	
K82-3052M	M12	1" Blind	0.47				
K82-3053M		1" Thru					
K82-3064M		1" Blind					
K82-3065M	M16	1" Thru					

Components

TOOLING BALLS

Tooling balls provide a precision reference point for critical inspection and machining operations. Standard and shoulder types are available with slip fit or light press fit shank diameters. Heat treated and precisely ground to a high luster finish. Rigid and reliable one-piece construction. Material: 1144, Rc 54-56.

Standard Tooling Balls

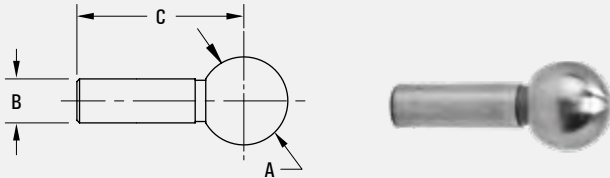

- * Slip-fit shank tolerance is +0.0000, -0.0004.
- * Press-fit shank tolerance is +0.0003, -0.0000.
- * Ball and shank are concentric within 0.0002 T.I.R.

Material 1144 Heat Treated to Rc 54-56

Part No.		A ±0.0002"	B	C
Slip Fit	Press Fit			
826705	826706	0.2500	0.1250	9/16
826710	826711	0.3750	0.1875	3/4
826715	826716	0.5000	0.2500	15/16
826720	826721	0.5000	0.2500	1-1/2
826725	826726	0.5000	0.3125	1-1/2
826730	826731	0.5000	0.3750	1-1/2

Shoulder Tooling Balls

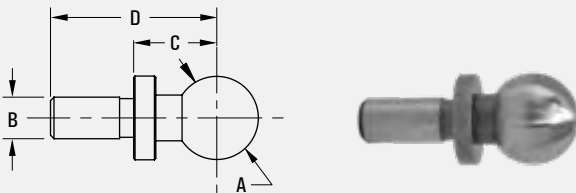

- * Slip-fit shank tolerance is +0.0000, -0.0004.
- * Press-fit shank tolerance is +0.0003, -0.0000.
- * Ball and shank are concentric within 0.0002 T.I.R.

Material 1144 Heat Treated to Rc 54-56

Part No.		A ±0.0002"	B	C ±0.0002"	D
Slip Fit	Press Fit				
826805	826806	0.2500	0.1250	0.200	9/16
826807	826808	6 mm	3 mm	6 mm	12 mm
826810	826811	0.3750	0.1875	0.300	3/4
826815	826816	0.5000	0.2500	0.400	15/16
826820	826821	0.5000	0.2500	0.500	1-3/8
826825	826826	0.5000	0.3125	0.500	1-1/2
826830	826831	0.7500	0.3750	0.500	1-1/4
826840		1.0000	0.2500	0.860	1-1/2

Toolmaker's Construction Balls

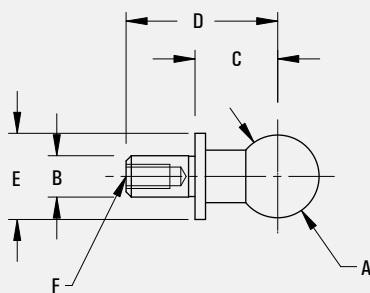

Material 1144 Heat Treated to Rc 54-56

Available with tapped hole for screw mounting. Shoulder provides precise base to centerline dimension to facilitate locating ball center.

Part No.		A ±0.0002"	B ±.0004"	C ±0.0002"	D	E	F
Tapped	No Hole						
826875		0.5000	0.2500	0.3125	5/8	0.49	#6-32 x 1/4 depth
	826877				5/8	0.49	
826820-SA					0.94	0.46	#6-32 x 5/16 depth
	826883	12 mm	6 mm	12 mm	22 mm	12 mm	
826885					22 mm	12.5 mm	#6-32 x 6 mm depth
	826887				22 mm	12.5 mm	
826889					25 mm	12 mm	M3.5 x 6 mm depth

T-Bolts

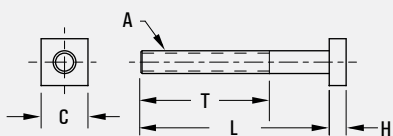

Material Finish

**Alloy Steel
Black Oxide**

- Heat treated to Grade 5 (125,000 psi) and black oxide finish.

Regular T-Bolts

L	A: 3/8-16		A: 1/2-13		A: 5/8-11		A: 3/4-10		A: 1"-8	
	H: 1/4	C: 11/16	H: 5/16	C: 7/8	H: 13/32	C: 1-1/8	H: 17/32	C: 1-5/16	H: 5/8	C: 1-11/16
	Part No.	T	Part No.	T	Part No.	T	Part No.	T	Part No.	T
1.5	841503	1.25	841003	1.25	841103	1.25				
2.0	841504	1.75	841004	1.75	841104	1.75	841204	1.75		
2.5	841505	2.00	841005	2.0	841105	2.0	841205	2.0		
3.0	841506	2.00	841006	2.0	841106	2.0	841206	2.0		
3.5	841507	2.00	841007	2.0	841107	2.0	841207	2.0		
4.0	841508	2.00	841008	2.0	841108	2.0	841208	2.0	841408	4
4.5					841109	2.0				
5.0	841510	2.00	841010	2.0	841110	2.0	841210	2.0	841410	4
6.0			841012	2.5	841112	2.5	841212	2.5	841412	4
7.0							841214	2.5	841414	4
8.0							841216	2.5	841416	4
10									841420	4

Stainless Steel T-Bolts

L	A: 3/8-16		A: 1/2-13		A: 5/8-11		A: 3/4-10	
	H: 1/4	C: 11/16	H: 5/16	C: 7/8	H: 13/32	C: 1-1/8	H: 17/32	C: 1-5/16
	Part No.	T	Part No.	T	Part No.	T	Part No.	T
1.5	841S503	1.25	841S003	1.25				
2.0	841S504	1.75	841S004	1.75				
2.5	841S505	2.00	841S005	2.00				
3.0	841S506	2.00	841S006	2.00				
3.5			841S007	2.00				
4.0			841S008	2.00	841S108	2.0		
5.0			841S010	2.00	841S110	2.0	841S210	2.0
6.0			841S012	2.50	841S112	2.5	841S212	2.5
8.0			841S016	2.50	841S116	2.5	841S216	2.5

Metric Thread (mm)

L	A: M10		A: M12		A: M16		A: M20	
	H: 6.4	C: 17.5	H: 7.9	C: 22.2	H: 9.5	C: 25.4	H: 13.5	C: 25.4
	Part No.	T	Part No.	T	Part No.	T	Part No.	T
40	841M10040	30						
50	841M10050	45	841M12050	45	841M16050	45	841M20050	45
65			841M12065	50				
75	841M10075	50	841M12075	50	841M16075	50	841M20075	50
90	841M10100	50	841M12090	50				
100			841M12100	50	841M16100	50	841M20100	50
125			841M12125	50				
150					841M16150	65		

Components

T-BOLTS

T-Slot Bolts

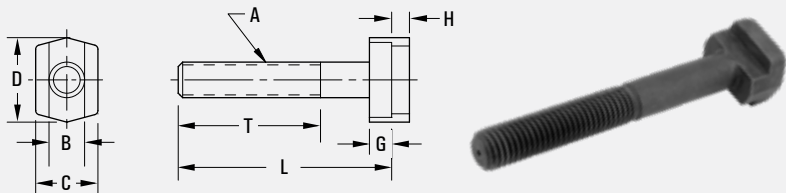

Material Alloy Steel
Finish Black Oxide

- All contact surfaces on head are machined.
- Heat treated to Grade 5 (125,000 psi)

A: 3/8-16	D: 13/16	A: 1/2-13	D: 1-3/16	A: 5/8-11	D: 1-5/16	A: 3/4-10	D: 1-1/2	A: 1"-8	D: 2-1/16					
B: 0.375	G: 3/16	B: 0.500	G: 5/16	B: 0.625	G: 11/32	B: 0.750	G: 13/32	B: 1.00	G: 7/16					
C: 11/16	H: 3/16	C: 7/8	H: 1/4	C: 1-1/8	H: 11/32	C: 1-1/4	H: 15/32	C: 1-3/4	H: 11/16					
Part No.	L	T	Part No.	L	T	Part No.	L	T	Part No.	L	T			
842310	1.0	0.75	842515	1.5	1.0	842620	2.0	1.5	842725	2.5	2.0	842940	4	2.5
842315	1.5	1.0	842520	2.0	1.5	842625	2.5	2.0	842730	3.0	2.0	842950	5	2.5
842320	2.0	1.5	842525	2.5	2.0	842630	3.0	2.0	842735	3.5	2.0	842960	6	2.5
842325	2.5	2.0	842530	3.0	2.0	842635	3.5	2.0	842740	4.0	2.5	842970	7	3.0
842330	3.0	2.0	842535	3.5	2.0	842640	4.0	2.5	842750	5.0	2.5	842980	8	3.5
842335	3.5	2.0	842540	4.0	2.5	842650	5.0	2.5	842760	6.0	2.5	842991	10	4.0
842340	4.0	2.5	842550	5.0	2.5	842660	6.0	2.5	842780	8.0	3.5			
			842560	6.0	2.5	842670	7.0	3.0						
						842680	8.0	3.5						

For Bridgeport Machine Tables:

A: 1/2-13	D: 1-1/4	
B: 0.625	G: 5/16	
C: 1"	H: 1/4	
Part No.	L	T
844530	3	2.0
844540	4	2.5
844550	5	2.5
844560	6	2.5

Rotary T-Slot Bolts

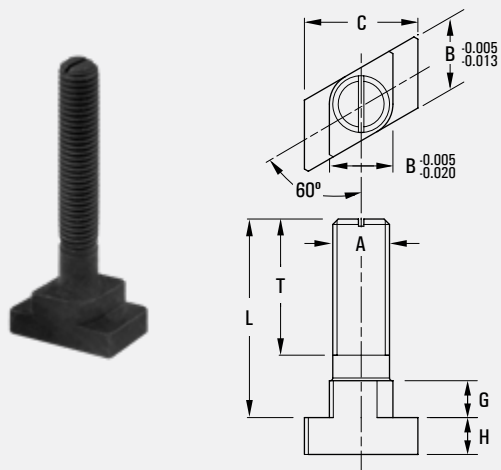

Material Alloy Steel
Finish Black Oxide

- Combines the convenience of the Rotary T-Slot Nut with the strength and simplicity of the forged T-Slot Bolts.
- Slot on the top of the bolt makes it easy to rotate the head in the T-Slot. Extra long threaded shank for versatility.
- Heat treated to Grade 5 strength.

Part No.	L	T	A	B	C	G	H
843515	1.5	1.0					
843520	2.0	1.5					
843525	2.5	2.0					
843530	3.0	2.5					
843535	3.5	2.5	1/2-13	0.625	1-1/8	11/32	11/32
843540	4.0	2.5					
843545	4.5	2.5					
843550	5.0	2.5					
843560	6.0	2.5					
843600	1.9	1.5	5/8-11	0.687	1-1/4	13/32	13/32
843615	1.5	1.0					
843620	2.0	1.5					
843625	2.5	2.0					
843630	3.0	2.5					
843635	3.5	2.5	5/8-11	0.750	1-1/4	13/32	13/32
843640	4.0	2.5					
843650	5.0	2.5					
843660	6.0	2.5					

Channel T- Bolts

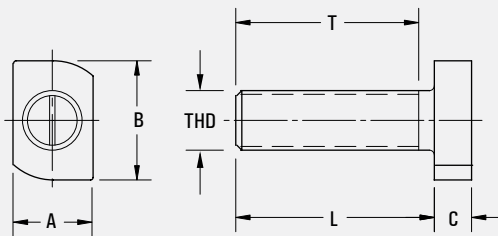

No slot on #10-24. Slot direction may be different from picture shown.

Material Carbon Steel
Finish Zinc Plated

- Special fastener with slot on the end. With a screw driver the T-head can be turned and locked in channel.
- The slot also facilitates fastening as the bolt can be steadied or retained in tight spots or odd positions.

Part No.	Thread	L	T	A	B	C
844106	10-24	5/8	5/8	0.18	0.377	0.065
844207	1/4-20	3/4	3/4	0.42	0.750	0.230
844210		1"	1"			
844307	5/16-18	3/4	3/4	0.42	0.750	0.230
844308		7/8	7/8			
844310		1"	1"			
844312		1-1/4	1-1/4			
844315		1-1/2	1-1/2			
844412	3/8-16	1-1/4	1-1/4	9/16	15/16	5/16
844520	1/2-13	2"	1-1/2	5/8	1-1/8	11/32
844535		3-1/2	2-1/2			
833539		4"	2-1/2			
844545		4-1/2	2-1/2			
844549		5"	2-1/2			
844559	6"	2-1/2				
844620	5/8-11	2"	1-1/2	3/4	1-1/4	13/32
844625		2-1/2	2"			
844630		3"	2-1/2			
844635		3-1/2	2-1/2			
844650		5"	2-1/2			
844660		6"	2-1/2			

T-Strap Bolts

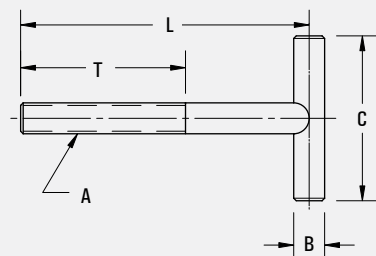

Material Medium Carbon Steel
Finish Zinc Plated

- T-Strap bolts are used to hold down parts. Ideal for strapping down heavy equipment.
- Used as hinge in tight-down setup, or simply as clamp down T-bolt.
- Heat treated to Grade 5 strength.

Part No.	A	B	C	L	T
840235C	1/4-20	1/4	1"	2"	1-1/2
840235F					
840335C	5/16-18	5/16	1-1/2	2-1/2	2"
840335F					
840435C	3/8-16	3/8	2"	3-1/2	2"
840435F					
840535C	1/2-13	1/2	2"	3-1/2	2-1/2
840535F					
840565C	1/2-13	1/2	2"	6-1/2	5-1/2
840565F					

Components

BOLTS

Lifting Eye Bolts

Material Carbon Steel
Finish Black Oxide (Inch sizes)
 Yellow Zinc Plated (Metric sizes)

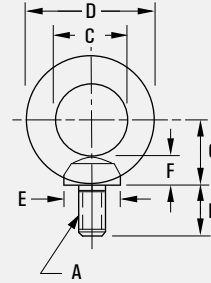

- Our shoulder design counteracts the inadvertent side load giving greater strength on angled pulls
- Shoulder eye bolts are designed for straight vertical pulls. General practice for other than vertical load per military standards are:
 - * 25% of the safe working load for a 45° load from vertical
 - * 20% of the safe working load for a 90° load from vertical
- For consistent heavy side load (90°) and where shock load may be anticipated, hoist rings with swiveling and pivoting features are to be used.

Part No.	A	B	C	D	E	F	G	Work Load (lbs.)
828015	M10 x 1.5	3/4	15/16	1-5/8	13/16	3/8	7/8	1,300
828020	1/2-13	7/8	1-3/16	2"	1"	7/16	1-1/8	2,400
828025	M12 x 1.75							
828030	5/8-11	1-1/16	1-3/8	2-3/8	1-1/8	9/16	1-1/4	4,000
828035	M16 x 2							
828040	3/4-10	1-3/16	1-1/2	2-5/8	1-3/8	3/4	1-5/16	5,000
828045	M20 x 2.5							

Jig Latch Bolts

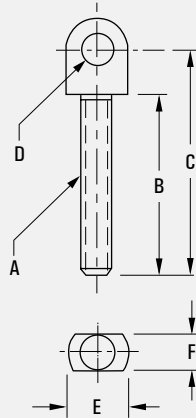

Material Alloy Steel
Finish Black Oxide

- Heat treated to grade 5 (125,000 p.s.i.) with oversized hole and full thread length.
- All holes are reamed + .001", + .003".

Part No.	A	B	C	D	E	F
832850	1/4-20	2-5/8	2-5/16	1/4	1/2	1/4
832855	5/16-18	3-3/16	2-13/16	5/16	5/8	5/16
832860	3/8-16	3-3/4	3-3/16	3/8	3/4	3/8
832865	1/2-13	4-7/8	4-5/16	1/2	1"	1/2

Swing Bolts

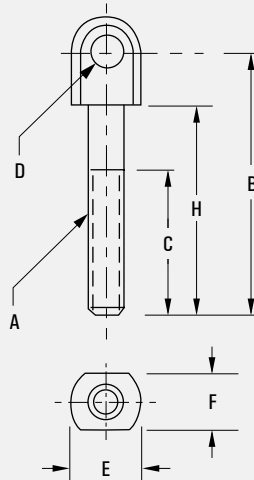

Material Alloy Steel
Finish Black Oxide

- Heat treated to grade 5 (125,000 p.s.i.).
- Stainless Steel available as a special order.

Part No.	A	B	H	C	D*	E	F
832700	1/4-20	1-1/2	1-3/16	3/4	1/4	1/2	5/16
832710		2-1/2	2-3/16	1-1/4			
832720	5/16-18	2"	1-5/8	1"	5/16	5/8	3/8
832730		3"	2-5/8	1-3/8			
832740	3/8-16	2-1/2	2"	1-3/8	3/8	3/4	1/2
832750		3-1/2	3"	2"			
832760	1/2-13	3-1/8	2-1/2	1-3/4	1/2	1"	5/8
832770		4-1/8	3-1/2	2-1/4			
832780	5/8-11	3-1/2	2-3/4	1-3/4	5/8	1-1/4	3/4
832790		4-3/4	4"	2-1/2			
832800	3/4-10	4-1/2	3-5/8	2"	3/4	1-1/2	7/8
832810		6"	5-1/8	3"			

* All holes are reamed +.001", +.003"

Plain Eye Bolts / Rod Ends

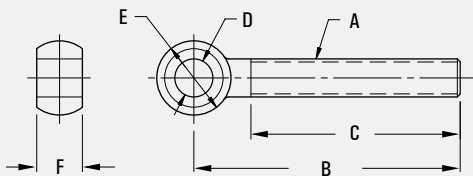

Material Alloy Steel
300 Series Stainless Steel (Metric Size)
Finish Black Oxide

- With our special extended thread length eye bolts, you can shorten the shank without sacrificing thread length.
- Heat treated (125,000 p.s.i.). Alloy Steel only.

Metric Size

Part No.	A	B	C	D	E	F
832M06-075	M6 x 1.0	75	66	6 mm	12 mm	6 mm
832M08-100	M8 x 1.25	100	90	8	16	8
832M10-100	M10 x 1.5	100	85	10	20	10
832M10-125		125	110			
832M12-100	M12 x 1.75	100	85	12	24	12
832M12-125		125	110			
832M16-115	M16 x 2.0	115	95	16	32	16
832M16-150		150	130			
832M20-150	M20 x 2.5	150	125	20	40	20

Inch Size

Part No.	A	B	C	D	E	F
832400	1/4-20	2"	3/4	3/16	1/2	1/4
832402		3"	1-1/4			
832C2030		3"	3/4			
832404	5/16-18	3"	1-1/2	1/4	5/8	5/16
832406		4"	2"			
832408		3"	1-1/2			
832410	3/8-16	4"	2"	5/16	3/4	3/8
832411		4"	3-1/2 *			
832412		3"	1-1/2			
832416	7/16-14	3"	1-1/2	3/8	1"	7/16
832C4040		4"	1-1/2			
832417		3-3/4	2"			
832418		5"	2-1/2			
832419		5"	4-1/2 *			
832C4470	1/2-13	7"	6"	3/8	1"	1/2
832424		3-3/4	1-1/2			
832426		5"	2"			
832427		5"	4-1/2 *			
832C5040		4"	1-1/2			
832C5050	5"					
832428	5/8-11	4-1/2	2"	5/8	1-1/4	5/8
832430		6"	2-1/2			
832431		6"	5-1/4 *			
832C6050		5"	1-3/4			
832C6060		6"				
832C6070		7"				
832C6080		8"				
832432		3/4-10	4-1/2			
832434	6"		2-1/2			
832435	6"		5-1/4 *			
832C7050	5"		1-3/4			
832C7060	6"					
832C7070	7"					
832C7080	8"					
832C1010	1"-8			10"	9" *	5/8

* Extended Thread Eye Bolts.

Components

EYE BOLTS / ROD ENDS

Stainless Steel Eye Bolts / Rod Ends

Material 304 Series Stainless Steel
Finish Plain

- Machined eye bolt provides close tolerances for assembly.
- Extended thread length allows for shortening while maintaining enough length to cover many applications.

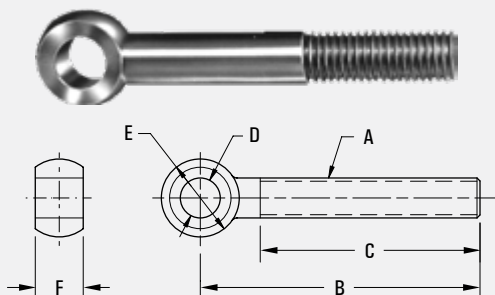

Extended Thread

Part No.	A	B	C	D	E	F
832SF2030	1/4-20	3"	2-1/2	1/4	1/2	1/4
832SF3040	5/16-18	4"	3-1/2	5/16	5/8	5/16
832SF4050	3/8-16	5"	4-1/2	3/8	3/4	3/8
832SF5050	1/2-13	5"	4-1/2	1/2	1"	1/2
832SF6060	5/8-11	6"	5-1/4	5/8	1-1/4	5/8
832SF7060	3/4-10	6"	5-1/8	3/4	1-1/2	3/4

Part No.	A	B	C	D	E	F
832S4030	3/8-16	3"	1-1/2	3/8	3/4	3/8
832S4040		4"				
832S5040	1/2-13	4"	1-1/2	3/8	1"	1/2
832S5050		5"				
832S5060		6"				
832S6060	5/8-11	6"	1-3/4	5/8	1-1/4	5/8
832S6070		7"				
832S6080		8"				
832S7050	3/4-10	5"	1-3/4	5/8	1-1/2	3/4
832S7070		7"				
832S7080		8"				
832S7150	3/4-10	5"	1-3/4	3/4	1-1/2	3/4
832S7170		7"				

Blank Rod Ends

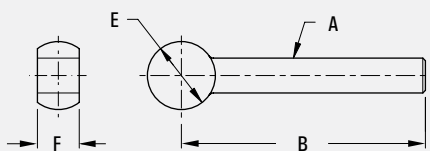

Material Alloy Steel / Stainless Steel
Finish Plain

- These blanks are fully machined to close dimension, but are not heat treated.
- Center drilled on head for easy modification.
- Shank diameter is centerless ground.

5140 Alloy Carbon Steel

Part No.	A	B	E	F
831C2030	1/4	3"	1/2	1/4
831C3015	5/16	1-1/2	5/8	5/16
831C3030		3"		
831C3040		4"		
831C3060		6"		
831C4017	3/8	1-3/4	3/4	3/8
831C4020		2"		
831C4025		2-1/2		
831C4030		3"		
831C4035		3-1/2		
831C4040		4"		

5140 Alloy Carbon Steel

Part No.	A	B	E	F
831C5030	1/2	3"	1"	1/2
831C5035		3-1/2		
831C5060		6"		
831C6030	5/8	3"	1-1/4	5/8
831C6055		5-1/2		
831C6065		6-1/2		
831C6080		8"		
831C7050	3/4	5"	1-1/2	3/4
831C8045	7/8	4-1/2	1-3/4	7/8
831C8050		5"		
831C9045	1"	4-1/2	2"	1"
831C9275	1-1/4	7-1/2	2-1/2	1-1/4

Socket Shoulder Screws

Material Medium Carbon Steel & Stainless Steel
Finish Black Oxide

- Shoulder screws are used as pivoting points and retaining bolts for Swing C-Washers, Clamp Straps, and Slip Fit Bushings.
- "A" diameter is precision ground and shoulder height is controlled.
- Hex socket on head makes assembling easy.

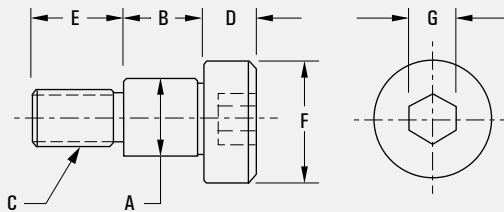

Precision Series : A +0.000, -0.001
 B +0.005, -0.000
Economy Series: A - 0.002, -0.004
 B +0.005, -0.005

Economy Series

Part No.		A	B	C	D	E	F	G
Carbon	Stainless	-.002 / -.004	+.005 / -.005					
831207E	831207SE	1/4	3/4	10-24	3/16	3/8	3/8	1/8
831310E	831310SE	5/16	1"	1/4-20	7/32	7/16	7/16	5/32
831317E	831317SE		1-3/4					
831422E	831422SE	3/8	2-1/4	5/16-18	1/4	1/2	9/16	3/16
831430E	831430SE		3"					
831529E	831529SE	1/2	2-61/64	3/8-16	5/16	5/8	3/4	1/4

Precision Series

Part No.	A	B	C	D	E	F	G
	+.000 / -.001	+.005 / -.000					
831202	1/4	1/4	10-24	3/16	3/8	3/8	1/8
831203		5/16					
831204		3/8					
831205		1/2					
831206		5/8					
831207		3/4					
831208		7/8					
831210		1"					
831302	5/16	1/4	1/4-20	7/32	7/16	7/16	5/32
831303		5/16					
831304		3/8					
831305		1/2					
831306		5/8					
831307		3/4					
831310		1"					
831402	3/8	1/4	5/16-18	1/4	1/2	9/16	3/16
831403		5/16					
831404		3/8					
831405		1/2					
831406		5/8					
831407		3/4					
831408		7/8					
831410		1"					
831504	1/2	3/8	3/8-16	5/16	5/8	3/4	1/4
831505		1/2					
831506		5/8					
831507		3/4					
831508		7/8					
831510		1"					
831605	5/8	1/2	1/2-13	3/8	3/4	7/8	5/16
831606		5/8					
831607		3/4					
831608		7/8					
831610		1"					
831705		3/4					
831706	5/8						
831707	3/4						
831708	7/8						
831710	1"						
831712	1-1/4						

Components

WASHERS

C-Washers

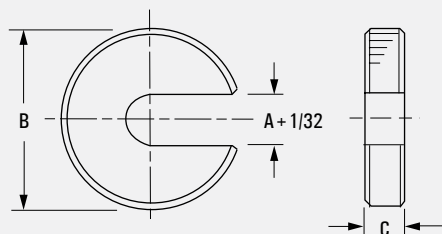

Material Carbon Steel
Finish Black Oxide

- Case hardened.
- Top and bottom surfaces ground parallel, and black oxide finish.
- OD knurled for sure grip.

Part No.	A	B	C
826000		3/4	
826002	1/4	1"	1/4
826004		1-1/4	
826010		1"	
826012	5/16	1-1/4	5/16
826014		1-1/2	
826016		1-1/4	
826018	3/8	1-1/2	3/8
826020		1-3/4	

Part No.	A	B	C
826022		1-7/8	
826024	1/2	2-1/4	3/8
826026		2-3/4	
826028		2-1/8	
826030	5/8	2-1/2	3/8
826032		3"	
826034		2-1/2	
826036	3/4	2-7/8	7/16
826038		3-3/8	

Swing C-Washers

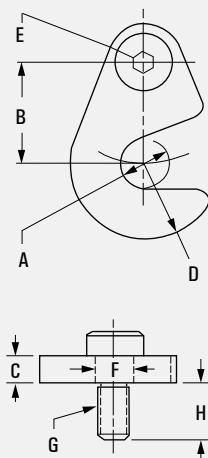

Material Carbon Steel
Finish Black Oxide

- Used for retaining mandrel mounted parts in jigs.
- Case hardened, ground on both sides and black oxide finish.
- Matching shoulder screw included.

Part No.	A	B	C	D	E	F	G	H
826210	7/16	1"	1/4	3/4	3/8	3/8	5/16-18	1/2
826215	17/32	1-1/4	5/16	1"	1/2			
826220	11/16	1-1/2	3/8	1-1/8	9/16	1/2	3/8-16	5/8
826225	53/64	1-3/4	1/2	1-1/4	5/8			

Spherical Washers

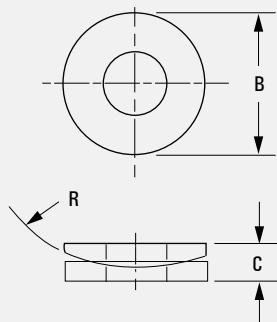

Material Carbon Steel
Finish Black Oxide

- Spherical washers act like a ball and socket to compensate for slight misalignment.
- Use in pairs, or use the bottom with our spherical flange nuts.
- Case hardened.

Set	Part No.		Stud Dia.	B	C	R
	Top Washers	Bottom Washers				
826250	826350	826450	1/4	5/8	3/16	3/4
826255	826355	826455	5/16	3/4	1/4	1"
826260	826360	826460	3/8	7/8	1/4	1-1/4
826263	826363	826463	7/16	1"	5/16	1-1/2
826265	826365	826465	1/2	1-1/8	5/16	1-1/2
826270	826370	826470	5/8	1-3/8	5/16	1-3/4
826275	826375	826475	3/4	1-5/8	3/8	2-1/4
826280	826380	826480	7/8	1-3/4	3/8	2-1/2
826285	826385	826485	1"	2"	1/2	2-3/4
826290	826390	826490	1-1/8	2-1/4	1/2	3"
826295	826395	826495	1-1/4	2-5/8	1/2	3"
826300	826400	826500	1-1/2	2-7/8	9/16	3"

Check Nuts

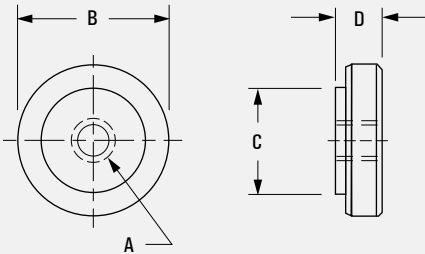

Material Carbon Steel
Finish Black Oxide

- Knurled OD, with minimal thickness.
- Required for hand tightening in many applications.

Part No.	A	B	C	D
853300	10-32	3/4	7/16	3/16
853305	1/4-20	3/4	1/2	7/32
853310	5/16-18			1/4
853315	3/8-16	1"	3/4	7/16
853320	1/2-13			

Flange Nuts

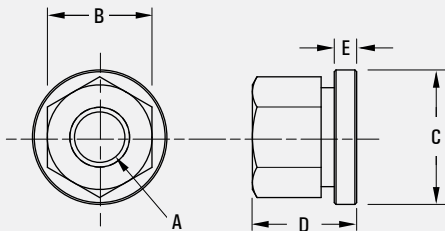

Material Heat Treated Steel
Finish Black Oxide

- Large bearing area ensures full surface contact with clamping component.

Part No.	A	B	C	D	E
825160	3/8-16	11/16	7/8	1/2	3/32
825165	1/2-13	7/8	1-1/8	11/16	3/16
825170	5/8-11	1-1/16	1-3/8	13/16	3/16
825175	3/4-10	1-1/4	1-5/8	1"	1/4
825185	1"-8	1-5/8	2"	1-1/4	1/4

Swivel Nuts

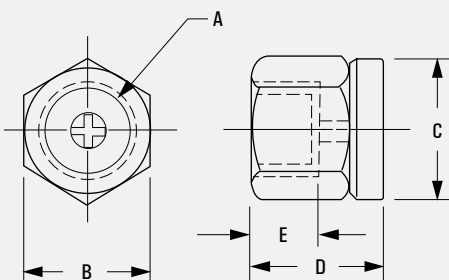

Material Heat Treated Steel
Finish Black Oxide

- Rotating, and hardened shoe pad prevents marring or moving of part when clamped.

Part No.	A	B	C	D	E
825300	10-24	1/4	5/16	5/16	13/64
825305	1/4-20	5/16	3/8	13/32	3/16
825310	5/16-18	3/8	7/16	15/32	1/4
825315	3/8-16	7/16	1/2	17/32	17/64
825320	1/2-13	5/8	11/16	21/32	3/8
825325	5/8-11	3/4	7/8	27/32	7/16
825330	3/4-10	7/8	1"	1"	1/2

Components

NUTS

Rotary Tee Nuts

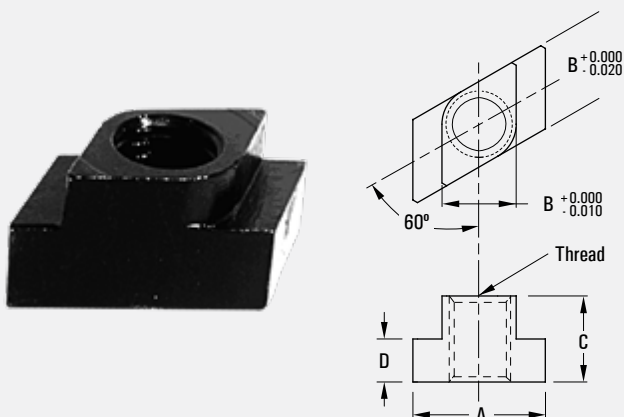

Material Alloy Steel
Finish Black Oxide

- Add studs and clamp straps without tearing down previous set-ups. Supplements standard T-Slot Nuts.
- Case hardened. Last thread closed.

Inch Size

Part No.	Thread	Table Slots	A	B	C	D
825736	3/8-16	1/2	7/8	0.495	1/2	9/32
825755	1/2-13	9/16	7/8	0.557	5/8	11/32
825756		5/8	1"	0.620	5/8	11/32
825757		11/16	1-1/8	0.682	3/4	7/16
825765	5/8-11	11/16	1-1/8	0.682	3/4	7/16
825766		3/4	1-1/4	0.745	3/4	15/32
825777	3/4-10	1"	1-5/8	0.995	1"	5/8

Metric Thread

Part No.	Thread	Table Slots	A	B	C	D
825736M	M10	1/2	7/8	0.495	1/2	9/32
825755M	M12	9/16	7/8	0.557	5/8	11/32
825756M		5/8	1"	0.620	5/8	11/32
825757M		11/16	1-1/8	0.682	3/4	7/16
825765M	M16	11/16	1-1/8	0.682	3/4	7/16
825766M		3/4	1-1/4	0.745	3/4	15/32

T-Slot Nuts

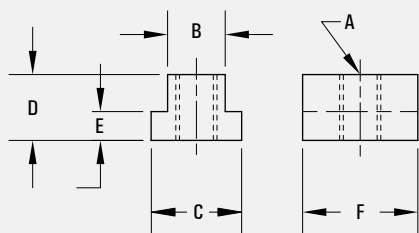
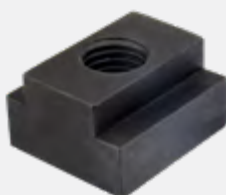

Material Carbon Steel
Finish Black Oxide

- Bottom of T-Slot Nut is staked to prevent the stud from protrusion. The B-dimension was made to be 0.005-0.010 under the width of the machine table.
- Case hardened.
- Last thread closed.

Part No.	A	B	C	D	E	F
825601	1/4-20	3/8	9/16	3/8	15/64	9/16
825602	5/16-18		5/8		1/4	7/8
825603	3/8-16	7/16	11/16	1/2	7/32	7/8
825604		1/2	7/8		9/32	
825607	1/2-13	9/16	7/8	5/8	11/32	1-1/8
825610	1/2-13	5/8	1"	5/8	11/32	1-1/8
825613		11/16	1-1/8	3/4	7/16	1-1/4
825614	5/8-11	11/16	1-1/8	3/4	7/16	1-1/4
825618	5/8-11	13/16	1-1/4	1"	9/16	1-1/2
825620	3/4-10				5/8	1-3/4
825624	3/4-10	7/8	1-1/2	1"	9/16	1-1/2
825627		1"	1-5/8		5/8	1-3/4

Safety Hoist Rings

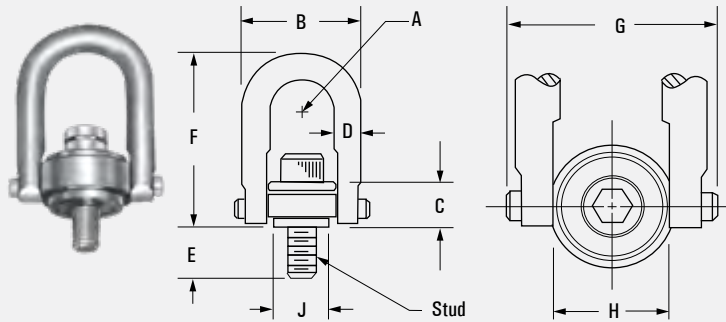

Material 4140 High Strength Alloy Steel
Heat Treated to 180,000 p.s.i.
Finish Black Oxide per mil spec.
(Cad plate available)

- These safety engineered hoist rings will swivel 360° and pivot 180°. They are the ultimate safety hoisting devices.
- Safety factor: 5 to 1
 - Magnetic particle inspected before assembled.
 - Certified heat treatment.
 - Metric thread sizes available.

Part numbers with * suffix are items with Long U-Bars

Part No.	Rated Load (lbs)	Thread Size	A	B	C	D	E	F	G	H	J	Torque Ft - lbs	Weight (lbs)	
866102	800	5/16-18	0.43	1.61	0.71	3/8	0.29	2.67	1.84	1.00	0.75	7	0.3	
866104														
866106														
866602	2,500	1/2-13	0.70	2.40	0.93	1/2	1.07	3.77	2.58	1.49	1.25	28	1.0	
866008													2.3	
866644 *													2.7	
866010													2.3	
866646 *													2.0	
866012													2.3	
866648													2.7	
866002													2.5	
866004													2.5	
866640 *													3.0	
866006	2.5													
866642 *	3.0													
866014	5,000	3/4-10	0.88	3.25	1.22	3/4	1.03	4.78	3.52	1.99	1.5	60	2.7	
866650 *													3.0	
866018													2.5	
866654 *													3.0	
866204													6.6	
866658 *													7.2	
866206	8,000	7/8-9	1.40	4.80	1.71	1"	1.54	6.52	5.14	3.00	2.37	160	6.8	
866660 *														6.6
866202														6.52
866656 *														8.11
866210	10,000	1"-8	1.40	4.93	1.71	1"	1.29	6.52	5.14	3.00	2.37	230	7.0	
866662 *														8.11
866212														6.52
866664 *														8.11
866214														6.52
866666 *														8.11
866802	15,000	1 1/4 - 7	1.75	6.00	2.11	1-1/4	1.89	8.73	6.50	3.76	3.20	470	14.0	
866404	24,000	1 1/2 - 6	2.25	8.00	2.81	1-3/4	2.70	12.47	8.55	4.87	4.20	800	33.8	
866400	30,000	2" - 4 1/2					2.96							
867002	50,000	2 1/2 - 8	3.00	10.50	4.09	2-1/4	4.00	16.87	11.67	6.52	5.75	2,100	87.5	
867006		2 1/2 - 4												
867200	75,000	3" - 4	3.75	13.00	5.27	2-3/4	5.20	19.50	14.15	8.10	7.25	4,300	166.0	
867402	100,000	3 1/2 - 4	4.00	14.50	6.06	3-1/4	7.00	22.09	15.90	8.60	7.73	5,100	265.0	

Heavy Duty Hoist Rings

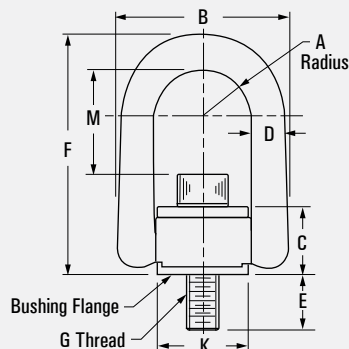

Material 4140 High Strength Alloy Steel
Heat treated to 180,000 p.s.i.
Finish Black Oxide

- Range of movement: Pivot 180°, swivel 360°
- MINIMUM SAFETY FACTOR = 5:1
- Meets Military Specification No. MIL-STD 1365(11) or MIL-STD 209C
- Heavy Duty Hoist Rings are specified and used in Nuclear Energy Equipment.
- 100% Magnetic Particle Inspected
- Meets OSHA Standards
- Destructive testing by outside independent laboratories
- OVER 30 YEARS OF RELIABILITY
- World's largest inventory. Over 95% of standards shipped in one day from stock.

Part No.	Rated Load (lbs)	A	B	C	D	E	F	G	K	TL* Ft-lbs.	M	Weight (lbs)
833112	550	0.65	2.29	0.96	0.44	0.56	3.23	1/4-20	1.25	5	1.57	0.50
833212	800	0.65	2.29	0.96	0.44	0.56	3.23	5/16-18	1.25	7	1.51	0.52
833214	800	0.65	2.29	0.96	0.44	1.06	3.23	5/16-18	1.25	7	1.51	0.54
833312	1,000	0.65	2.29	0.96	0.44	0.56	3.23	3/8-16	1.25	12	1.45	0.56
833314	1,000	0.65	2.29	0.96	0.44	1.06	3.23	3/8-16	1.25	12	1.45	0.58
833512	2,500	1.00	3.50	1.50	0.75	0.75	5.31	1/2-13	1.89	28	2.56	1.71
833515	2,500	1.00	3.50	1.50	0.75	1.00	5.31	1/2-13	1.89	28	2.56	1.72
833516	2,500	1.00	3.50	1.50	0.75	1.25	5.31	1/2-13	1.89	28	2.56	1.82
833612	4,000	1.00	3.50	1.50	0.75	0.75	5.31	5/8-11	1.89	60	2.44	1.76
833614	4,000	1.00	3.50	1.50	0.75	1.00	5.31	5/8-11	1.89	60	2.44	1.78
833615	4,000	1.00	3.50	1.50	0.75	1.25	5.31	5/8-11	1.89	60	2.44	1.88
833714	5,000	1.00	3.50	1.50	0.75	1.00	5.31	3/4-10	1.89	100	2.31	1.89
833716	5,000	1.00	3.50	1.50	0.75	1.50	5.31	3/4-10	1.89	100	2.31	2.02
833108	7,000	1.40	5.10	2.05	1.00	0.95	7.00	3/4-10	2.81	100	3.20	7.20
833102	7,000	1.40	5.10	2.05	1.00	1.20	7.00	3/4-10	2.81	100	3.20	7.23
833103	7,000	1.40	5.10	2.05	1.00	1.45	7.00	3/4-10	2.81	100	3.20	7.25
833104	8,000	1.40	5.10	2.05	1.00	0.95	7.00	7/8-9	2.81	160	3.07	7.33
833101	8,000	1.40	5.10	2.05	1.00	1.20	7.00	7/8-9	2.81	160	3.07	7.33
833105	10,000	1.40	5.10	2.05	1.00	1.45	7.00	1"-8	2.81	230	2.95	7.57
833106	10,000	1.40	5.10	2.05	1.00	1.20	7.00	1"-8	2.81	230	2.95	7.63
833107	10,000	1.40	5.10	2.05	1.00	2.20	7.00	1"-8	2.81	230	2.95	7.81
833402	15,000	2.00	6.75	2.87	1.25	1.88	9.22	1 1/4-7	3.88	470	3.74	15.74
833401	15,000	2.00	6.75	2.87	1.25	2.63	9.22	1 1/4-7	3.88	470	3.74	16.0
833420	20,000	2.00	6.75	2.87	1.25	2.63	9.22	1 3/8-6	3.88	670	3.62	17.2
833424	24,000	2.00	6.75	2.87	1.25	2.63	9.22	1 1/2-6	3.88	800	3.49	18.1
833427	30,000	2.00	6.75	2.87	1.25	2.96	9.22	2"-4 1/2	3.88	800	3.49	22.9
833432	30,000	2.00	6.75	2.87	1.25	2.96	9.22	2"-8	3.88	800	3.49	22.9

* Recommended Torque Load

Use Hoist Rings for added lifting safety

Side or angular pulling forces can cause eye bolts to twist, bend, or break when heavy, angular, unbalanced loads are involved.

Part No.	Rated Load (kg)	A	B	C	D	E	F	G	K	TL* N.M.	M	Weight (lbs)
834212	400	16.5	58.2	24.4	11.1	16	82.0	M8 x 1.25	31.8	9.5	38.5	0.24
834214	400	16.5	58.2	24.4	11.1	21	82.0	M8 x 1.25	31.8	9.5	38.5	0.25
834312	450	16.5	58.2	24.4	11.1	16	82.0	M10 x 1.5	31.8	16.0	36.5	0.25
834314	450	16.5	58.2	24.4	11.1	26	82.0	M10 x 1.5	31.8	16.0	36.5	0.26
834515	1,050	25.4	88.9	38.1	19.1	25	134.9	M12 x 1.75	48.0	37.0	65.0	0.78
834516	1,050	25.4	88.9	38.1	19.1	32	134.9	M12 x 1.75	48.0	37.0	65.0	0.83
834614	1,900	25.4	88.9	38.1	19.1	25	134.9	M16 x 2.0	48.0	80.0	62.0	0.81
834615	1,900	25.4	88.9	38.1	19.1	32	134.9	M16 x 2.0	48.0	80.0	62.0	0.85
834714	2,200	25.4	88.9	38.1	19.1	25	134.9	M20 x 2.5	48.0	135.0	58.7	0.86
834716	2,200	25.4	88.9	38.1	19.1	38	134.9	M20 x 2.5	48.0	135.0	58.7	0.92
834101	3,000	35.6	129.5	52.1	25.4	28	177.8	M20 x 2.5	71.4	135.0	81.0	3.14
834102	4,200	35.6	129.5	52.1	25.4	28	177.8	M24 x 3.0	71.4	311.0	76.3	3.29
834103	4,200	35.6	129.5	52.1	25.4	38	177.8	M24 x 3.0	71.4	311.0	76.3	3.30
834105	4,500	35.6	129.5	52.1	25.4	38	177.8	M30 x 3.5	71.4	311.0	70.3	3.44
834107	4,500	35.6	129.5	52.1	25.4	48	177.8	M30 x 3.5	71.4	311.0	70.3	3.55
834401	7,000	50.8	171.5	72.9	31.8	67	234.2	M30 x 3.5	73.2	637.2	95.0	7.26
834402	11,000	50.8	171.5	72.9	31.8	67	234.2	M36 x 4.0	73.2	1,085.5	88.6	8.21
834403	12,500	50.8	171.5	72.9	31.8	80	234.2	M42 x 4.5	73.2	1,085.5	88.6	10.14
834404	13,500	50.8	171.5	72.9	31.8	80	234.2	M48 x 5.0	73.2	1,085.5	88.6	10.59

* Recommended Torque Load

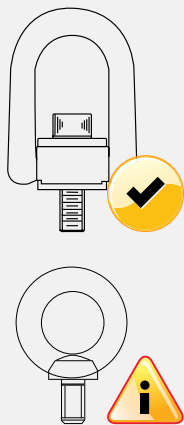
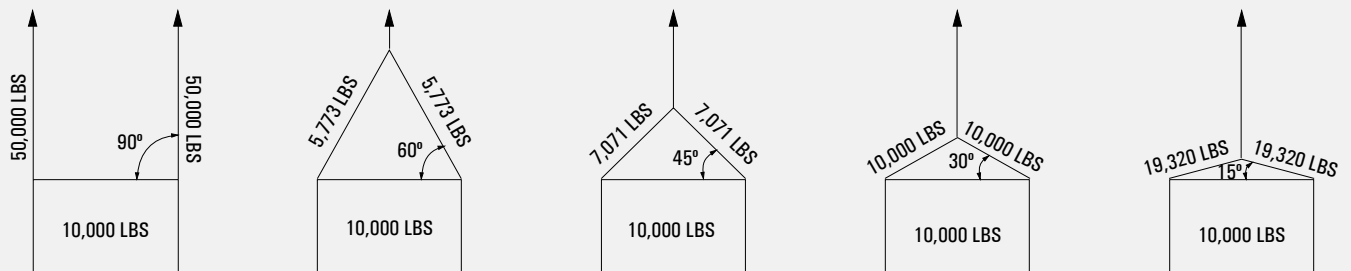

Heavy Duty Hoist Rings

Thread Size	Rated Load Capacity / lbs.		
	Straight Pull	45° Lift	90° Lift
1/4-20	550	550	550
5/16-18	800	800	800
3/8-16	1,000	1,000	1,000
1/2-13	2,500	2,500	2,500
5/8-11	4,000	4,000	4,000
3/4-10	5,000	5,000	5,000
7/8-9	8,000	8,000	8,000
1-8	10,000	10,000	10,000
1-1/4-7	15,000	15,000	15,000
1-1/2-6	24,000	24,000	24,000

Shoulder Eye Bolts

Thread Size	Rated Load Capacity / lbs.		
	Straight Pull	45° Lift	90° Lift
1/4-20	480	144	120
5/16-18	800	240	200
3/8-16	1,200	360	300
1/2-13	2,200	660	550
5/8-11	3,500	1,050	875
3/4-10	5,200	1,560	1,300
7/8-9	7,200	2,160	1,800
1-8	10,000	3,000	2,500
1-1/4-7	15,200	4,560	3,800
1-1/2-6	21,400	6,420	5,350

Rest Button

Material Heat Treated Steel
Finish Black Oxide

- Precision rest button with a press-fit shank. Excellent as either a workpiece support or a jig foot.

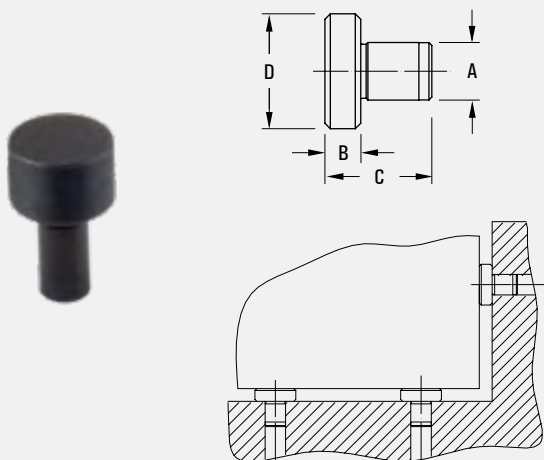

Part No.	A +.0000 / -.0005	B +.001 / -.000	C	D
646400-G	0.1885	0.250	5/8	3/8
646405-G		0.375	3/4	
646410-G		0.500	7/8	
646415-G	0.2510	0.250	3/4	1/2
646420-G		0.375	7/8	
646425-G		0.500	1"	
646445-G	0.3760	0.250	7/8	5/8
646450-G		0.375	1"	
646455-G		0.500	1-1/8	
646460-G		0.625	1-1/4	
646461-G		0.750	1-3/8	
646462-G	0.5010	0.438	1-1/16	7/8
646475-G		0.625	1-1/4	
646480-G		0.750	1-3/8	
646482-G	0.6260	0.438	1-3/16	1"
646490-G		0.500	1-1/4	
646515-G		0.7510	1-1/2	
646516-G	1.0010	0.750	2"	1-1/2

Bullet Nose Pins & Liners

Material Heat Treated Steel
Finish Black Oxide

- Bullet nose pins are often used together with matching liners to align two pieces of fixture. Two versions available, round and relieved.
- The relieved pins is to locate only radially around the round pin, avoiding redundant location and thus prevents binding, yet still maintain high accuracy.



Liners

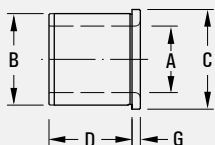

Round

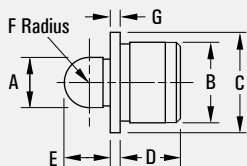

Relieved

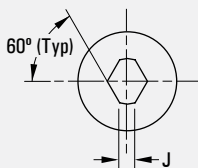
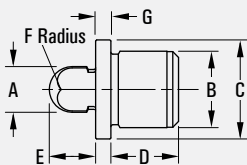

Liners

Part No.	A +.0004 / -.0000	B +.0000 / -.0003	C	D	G
677055-G	0.2501	0.4078	3/8	9/16	1/16
677060-G	0.3126	0.5017	3/8	5/8	1/16
677065-G	0.3751	0.6267	1/2	3/4	1/16
677070-G	0.5001	0.7518	1/2	7/8	1/16
677073-G	0.7502	1.0018	1/4	1-1/8	1/8
677075-G	1.0002	1.3771	1/4	1-1/2	1/8

Pins

Part No.		A +.0000 / -.0005	B +.0000 / .0003	C	D	E	F	G	J *	Used with Liner Part No.
Round	Relieved									
677005-G	677006-G	0.2499	0.4078	9/16	3/8	7/32	1/8	1/16	0.08	677055-G
677010-G	677011-G	0.3124	0.5017	5/8	3/8	9/32	5/32	1/16	0.10	677060-G
677015-G	677016-G	0.3748	0.6267	3/4	1/2	5/16	3/16	1/16	0.12	677065-G
677020-G	677021-G	0.4998	0.7518	7/8	1/2	13/32	1/4	1/16	0.17	677070-G
677023-G	677024-G	0.7498	1.0018	1-1/8	1/4	9/16	3/8	1/8	0.25	677073-G
677025-G	677028-G	0.9998	1.3771	1-1/2	1/4	3/4	1/2	1/8	0.33	677075-G

* For Relieved model only.

Bullet Nose Dowels & Liners

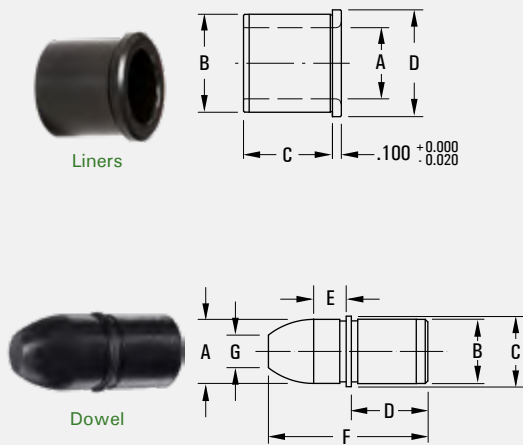

Material Heat Treated Steel
Finish Black Oxide

Liners

Part No.	A +0.004 / -0.0000	B +0.000 / -0.0003	C	D
677180-G	0.2501	0.5017	3/8	0.625
677185-G	0.3126	0.5017	3/8	0.625
677190-G	0.3751	0.6267	1/2	0.750
677195-G	0.5001	0.7518	5/8	0.875

Dowel

Part No.	A +0.000 -0.0005	B +.001 -.000	C	D	E	F	G	Used with Liner Part No.
677130-G	0.2499	0.2516	0.280	1/2	0.125	0.907	1/8	677180-G
677135-G	0.3124	0.3141	0.344	1/2	0.157	0.939	5/32	677185-G
677140-G	0.3749	0.3766	0.407	1/2	0.187	1.032	3/16	677190-G
677145-G	0.4999	0.5017	0.532	1/2	0.187	1.094	1/4	677195-G

Headless & Shoulder Retainers

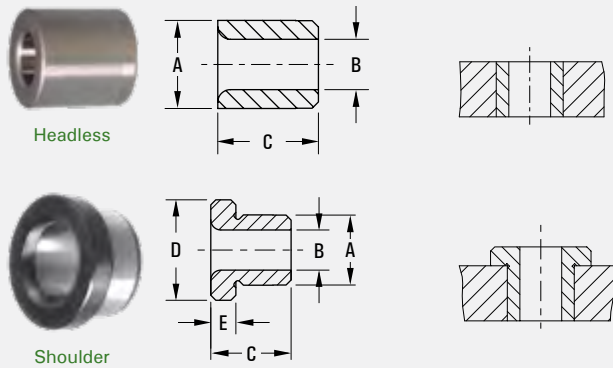

Material Heat Treated Steel

Headless Retainers

Part No.	A	B	C
635110-G	0.5017 / 0.5014	0.3126 / 0.3129	1/2
635120-G	0.7518 / 0.7515	0.5002 / 0.005	3/4
635130-G	1.0018 / 1.0015	0.7503 / 0.7506	1"

Shoulder Retainers

Part No.	A	B	C	D	E
635055-G	0.5017 / 0.5014	0.3126 / 0.3129	1/2	5/8	3/32
635065-G	0.7518 / 0.7515	0.5002 / 0.5005	3/4	7/8	3/32
635075-G	1.0018 / 1.0015	0.7503 / 0.7506	1"	1-1/8	1/8

Round & Diamond Pins

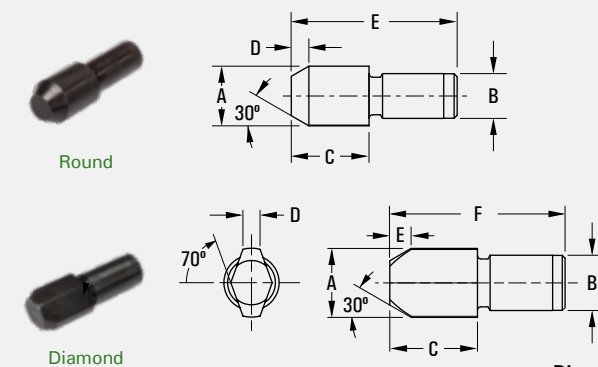

Material Heat Treated Steel

Round

Part No.	A	A Tolerance	B	B Tolerance	C	D	E
678005	1/4	0.2495 / 0.2492	3/16	0.1878 / 0.1876	11/32	3/32	3/4
678010	5/16	0.3120 / 0.3117	1/4	0.2503 / 0.2501	13/32		7/8
678015	3/8	0.3745 / 0.3742	5/16	0.3128 / 0.3126	1/2	1/8	1"
678020	1/2	0.4495 / 0.4492	7/16	0.4378 / 0.4376	21/32	5/32	1-3/8

Diamond

Part No.	A	A Tolerance	B	B Tolerance	C	D	E	F
678006	1/4	0.2493 / 0.2490	3/16	0.1878 / 0.1876	11/32	0.062	3/32	3/4
678011	5/16	0.3118 / 0.3115	1/4	0.2503 / 0.2501	13/32	0.078		7/8
678016	3/8	0.3743 / 0.3740	5/16	0.3128 / 0.3126	1/2	0.093	1/8	1"
678021	1/2	0.4993 / 0.4990	7/16	0.4378 / 0.4376	21/32	0.125	5/32	1-3/8

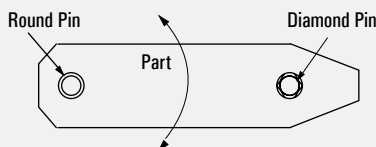

LEVELING PADS

Leveling Pads

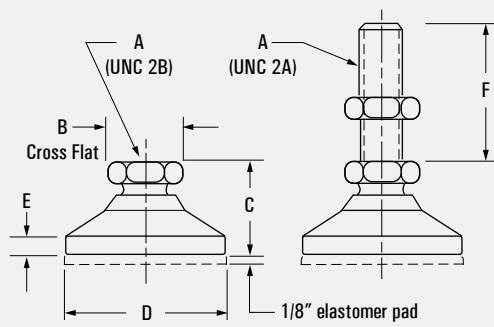

Material Carbon Steel
302 Stainless Steel

Finish Gold Iridite Zinc
Black Oxide

- Leveling pads can be used to level equipment or for clamping applications.
- The pad swivels 15° degrees from centerline.
- Comes in socket and stud types with optional elastomer pads that add non-slip padding.

Gold Iridite Zinc

Part No.		A	B	C	D	E	F	Weight Capacity (lbs.)
Socket	Stud							
854060	854062	1/4-20	1/2	0.70	1"	5/32	1-1/4	825
854065	854067	3/8-16	5/8	7/8	1-1/4	3/16	2"	2,850
854070	854072	1/2-13	3/4	1-1/8	1-7/8	1/4	2"	3,750
854075	854077	5/8-11	7/8	1-1/4	2-1/2	5/16	2"	4,350
854080	854082	3/4-10	1-1/16	1-1/2	3"	1/2	2"	5,500
854085	854087	1"-8	1-1/2	1-7/8	4"	13/32	4-1/4	16,500

Black Oxide

Part No.	
Socket	Stud
854060B	854062B
854065B	854067B
854070B	854072B
854075B	854077B
854080B	854082B
854085B	854087B

Stainless Steel

Part No.	
Socket	Stud
8540S60	8540S62
8540S65	8540S67
8540S70	8540S72
8540S75	8540S77
8540S80	8540S82
8540S85	8540S87

Leveling Pads - Plastic

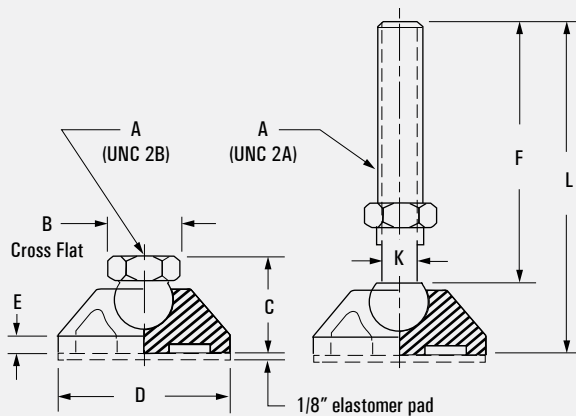

Material Pad - Strong Glass Filled Nylon
Socket & Stud - Medium Carbon Steel
Socket & Stud - 302 Stainless Steel

Finish Pad - Black
Socket & Stud - Zinc Plated

- A lighter weight, lower cost leveling, and support solution for today's equipment and instrumentation markets.
- Comes with elastomer pad.
- Available in Metric sizes. Custom length can be ordered as special.

Steel (inch)

Part No.		A	B	C	D	E	F	L	K	Weight Capacity (lbs.)
Socket	Stud									
	854122	1/4-20			1-5/8	0.20	2"	2-5/8	3/16	700
	854133	5/16-18					3"	3-5/8	1/4	
	854243	3/8-16					3"	3-11/16	5/16	
854250	854255	1/2-13	3/4	1.00	2"	0.25	5"	5-11/16	7/16	1,000
	854265	5/8-11					5"	5-11/16	9/16	
	854355	1/2-13			2-3/8	0.30	5"	6"	7/16	2,000
854360	854366	5/8-11	7/8	1.27			6"	7"	9/16	
	854376	3/4-10					6"	7"	11/16	

Stainless Steel

Part No.	
Socket	Stud
	8541S22
	8541S33
	8541S43
	8542S43
8542S50	8542S55
	8542S65
	8543S55
8543S60	8543S66
	8543S76

Stud Style (metric)

Part No.		A
Steel	Stainless	
8541M62	8541SM62	M6
8541M83	8541SM83	M8
8541M103	8541SM103	M10
8542M103	8542SM103	M10
8542M125	8542SM125	M12
8542M165	8542SM165	M16
8543M125	8543SM125	M12
8543M166	8543SM166	M16
8543M206	8543SM206	M20

Leveling Pads - Plastic with Lag Holes

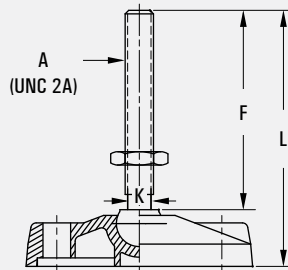
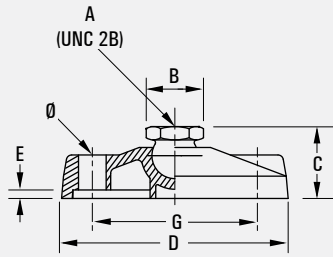

Material Pad - Strong Glass Filled Nylon
 Socket & Stud - Medium Carbon Steel
 Socket & Stud - 302 Stainless Steel

Finish Pad - Black
 Socket & Stud - Zinc Plated

- A lighter weight, lower cost leveling and support solution for today's equipment and instrumentation markets.
- Stainless steel socket and studs are available. Available in Metric. Custom length can be ordered as special.
- Comes with elastomer pad.

Stainless (inch)

Part No.	
Socket	Stud
	8545S43
8545S50	8545S55
	8545S65
	8546S55
8546S60	8546S66
	8546S76

Stud Style (metric)

Part No.		A
Steel	Stainless	
8545M103	8545SM103	M10
8545M125	8545SM125	M12
8545M165	8545SM165	M16
8546M125	8546SM125	M12
8546M166	8546SM166	M16
8546M206	8546SM206	M20

Steel (inch)

Part No.		A	B	C	D	E	F	L	K	Ø	G	Weight Capacity (lbs.)
Socket	Stud											
	854543	3/8-16		1-3/64	3-13/64	0.125	3"	3-3/4"	5/16"	0.35	2-1/8"	2,000
854550	854555	1/2-13	3/4"									
	854565	5/8-11										
	854655	1/2-13		1-17/64	4"	0.15	5"	6"	7/16"	0.51	2-59/64"	2,600
854660	854666	5/8-11	7/8"									
	854676	3/4-10										

Heavy Duty Fixed Glides

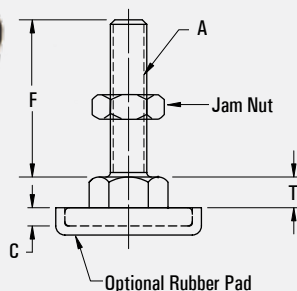
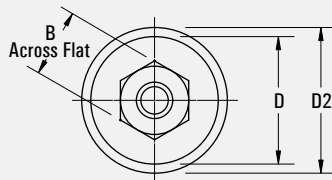

Material Carbon Steel

Finish Yellow Zinc Plated

- Extra large, thick hex for heavy duty leveling applications.
- Optional rubber feet prevent marring and skidding.
- Economical, ideal for bulky and heavy equipment.

Part No.		A	B across flat	C	D	D2	F	T
Standard	With Pad							
854720	854720P	1/4-20	1/2"	0.20	1.00	1.25	1.25	0.22
854730	854730P	5/16-18	5/8"	0.22	1.25	1.50	2.00	0.30
854740	854740P	3/8-16	5/8"	0.22	1.25	1.50	2.00	0.30
854750	854750P	1/2-13	15/16"	0.25	1.75	2.00	2.12	0.42
854760	854760P	5/8-11	15/16"	0.25	2.00	2.25	2.12	0.42

Components

SPRING STOPS & HOOK CLAMP ASSEMBLIES

Spring Stops



Square Nose

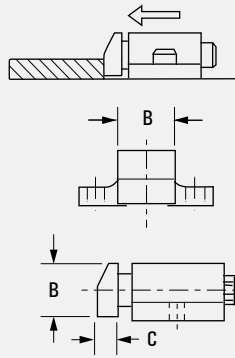

Material Body - Cast Iron (Medium and Large Sizes)
- Aluminum (All Sizes)
Nose - Heat Treated Steel

Finish Body - Plain
Nose - Black Oxide

- Temporarily hold work tight against locators.
- We have different spring stops to fulfill different needs: the round nose for general purpose tooling, the square one for thin parts

Spring stops with delrin plungers available as special order, add N suffix.

Part No.		Nose	Size	A	B	C	Pressure (lbs)
Aluminum	Cast Iron						
855000		Round	Small	19/32			10
855015	855010		Medium	7/8			14
855025	855020		Large	1-7/32			32
855050		Square	Small	19/32	3/8	1/8	10
855060	855055		Medium	9/16	19/32	1/4	14
855070	855065		Large	1-9/32	3/4	5/16	32

* End Pressures are measured at mid point of travel.



Round Nose

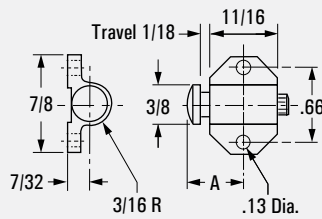
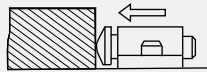

(Small)

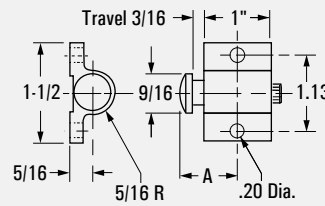

(Medium)

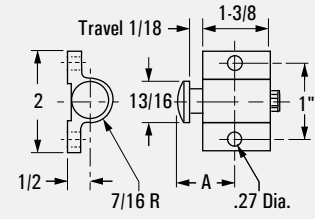

(Large)

Hook Clamp Assemblies



Socket Head Cap Screw Style

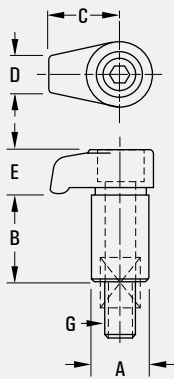

Stud and Nut Style

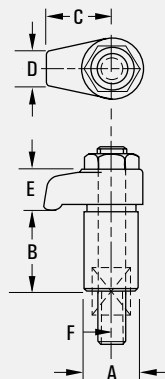

Material Case Hardened Alloy Steel
Finish Black Oxide

- Ideal for installation in jig or fixture where access is limited.
- Hook is spring-loaded for quick release and swings easily away from work piece.
- Supplied with cap screw or stud and nut. Spring included.
- Individual components can be purchased separately.

Socket Head Cap Screw Style

Assembly	Part No.		A +.000 /-0.001	B	C	D	E	G Cap Screw
	Body	Cap Screw						
821107	821106	SHCS-3017	0.624	7/8	11/16	7/16	1/2	5/16-18 x 1-3/4
821113	821112	SHCS-4030	0.874	1-21/32	1"	9/16	19/32	3/8-16 x 3"
821117	821116	SHCS-5035	0.999	1-3/4	1-3/16	3/4	13/16	1/2-13 x 3-1/2
821122	821121	SHCS-5035	1.124	1-11/16	1-7/16	7/8	7/8	1/2-13 x 3-1/2

Tolerance: -0.001

Stud and Nut Style

Assembly	Part No.			F Stud
	Body	Stud	Nut	
821105	821104	840105	825355	5/16-18 x 2-1/2
821110	821109	840308	825360	3/8-16
821115	821114	840309	825365	1/2-13 x 4-1/2
821120	821119	840410	825370	5/8-11 x 5"

Tolerance: -0.001

Forged Adjusta-Clamps



Forged Adjusta-Clamp Assemblies



Material Carbon Steel
Finish Black Oxide

- Rugged forged steel pivot clamp
- Instant height adjustment without blocks or shims. One piece assembly allows quick setups and eliminates lost clamp pieces.
- Removable brass shims protect machine table and work piece.
- Clamp can swing 90° in either direction for loading clearance.
- Fast Setup - save up to 90% of setup time.
- Simple - one piece design, no searching for the right step block and shim.
- Space-Saving - takes up little table space.
- Safe - Pivoting action will compensate for work piece variation.
- Versatile - Compact, single piece pivoting design. Numerous accessories make many unique applications possible.

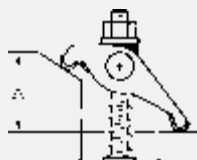
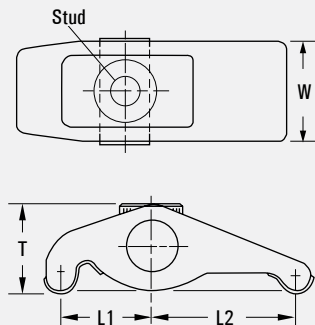

With riser blocks the Forged Adjusta-Clamps can be used for tall jobs.



Use to clamp two uneven workpieces.



No spacer needed, ideal for machine center tombstones or other vertical mountings.

Part No.	Stud Size	Clamping Range	L1	L2	T	W	Weight (lbs.)	Spring for FAC Assembly
850740	3/8	0 ~ 1-3/4	1-7/8	1-1/8	1"	1-1/4	0.6	850740-6
850750	1/2	0 ~ 2-1/16	2-5/16	1-7/16	1-7/16	1-5/8	1.1	850750-6
850760	5/8	0 ~ 3"	3-1/4	2"	1-7/8	1-7/8	2.4	850760-6
850770	3/4	0 ~ 4-1/4	3-1/2	2-1/8	2-1/4	2-5/8	3.8	850770-6
850790	1"	0 ~ 5-1/2	4"	2-1/4	2-7/16	3-1/8	5.2	850790-6

Components

CLAMPS

Cam Action Clamps



Standard Base



Extended Base

Material Body - Steel, Wear surface hardened
Handle - Phenolic black plastic
Finish Black Oxide

- Low profile quick action clamp with a jaw that pivots forward and downward at the same time when handle is turned.
- Locks positively at any position within its 180° turn and will hold parts that vary slightly in dimension.
- An extended base version allows position adjustment on machine tables.

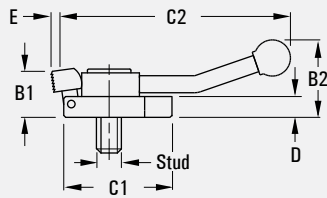
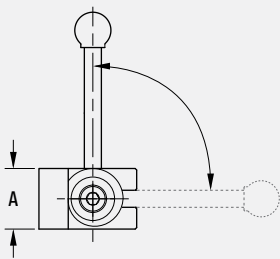

850290 | 850300

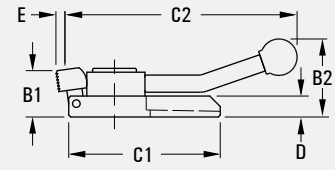
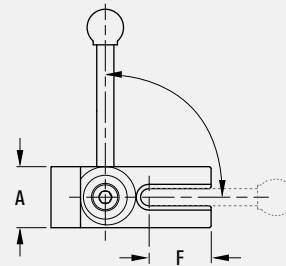

85295 | 850305

Part No.	Base	Stud	A	B1	B2	C1	C2	D	E	F
850290	Standard	5/16-18	1-1/4	1"	1-5/8	1-3/4	5"	7/16	1/8	
850295	Extended	5/16-18	1-1/4	1"	1-5/8	3-1/8	5"	7/16	1/8	1"
850300	Standard	1/2-13	1-7/8	1-1/2	2-1/2	2-3/4	7-1/2"	5/8	5/32	
850305	Extended	1/2-13	1-7/8	1-1/2	2-1/2	4-3/4	7-1/2"	5/8	5/32	1-1/2

Double Cams



Material Medium Carbon Steel
Finish Black Oxide

- Double cams are for fast change tooling applications that require moderate clamping force.
- Matching eye bolts and clamp straps available for your clamp assembly.
- An extended base version allows position adjustment on machine tables.

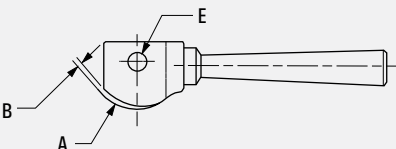
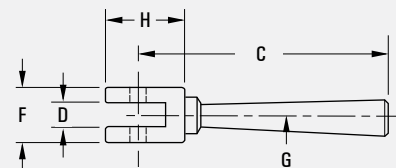

Part No.	A Radius	B Raise	C	D	E	F	G	H
849005	9/16	1/16	2-1/2	1/4	3/16	9/16	0.31	0.97
849010	11/16	1/16	3-1/2	5/16	1/4	5/8	0.38	1.21
849015	15/16	7/64	5"	1/2	3/8	1-1/8	0.55	1.39
849020	1-3/16	9/64	5-3/8	5/8	5/8	1-1/4	0.68	2.05

Bedding Support

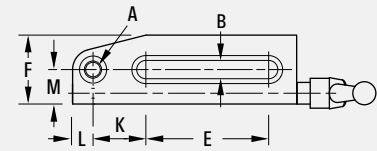
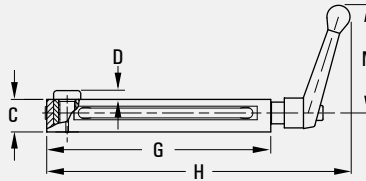

- Used in addition to the conventional three point fixed supports.
- Low profile unit can be slid under the workpiece and positioned where the cutter is most likely to create chatter and vibration.
- Spring-loaded plunger is first depressed and held down with the lock handle. Once positioned, the handle is released.
- Turning the handle will tighten the plunger to support a load of 500-1000 lbs. depending on the model.
- A 1/2-13 stud can be threaded into the plunger to raise height of the support.

Part No.	A
850201M	M8
850202M	M12
850203M	M16

Part No.	A	B	C	D (Max. Stroke)	E	F	G	H	K	L	M	N
850201	5/16-18	0.33	0.71	0.11	1-13/32	1-3/16	3-3/8	5-3/16	1-1/16	13/32	25/32	2-9/16
850202	1/2-13	0.53	0.95	0.23	3-9/16	2"	6-1/2	8-13/16	1-17/32	19/32	1"	3-1/8
850203	5/8-11	0.67	1.34	0.43	4-1/16	2-3/8	7-1/2	10-5/8	1-3/4	13/16	1-7/16	4-5/16

Upthrust Clamp



Material Alloy Steel
Finish Black Oxide

- Combination clamp and locator with a unique upward clamping action.
- Pushing down the cam handle pulls the lower jaw upward. This clamps the workpiece against the stationary upper jaw, whose bottom surface is a precision-ground locator.
- Both upper and lower jaws can be rotated 360° for easy positioning of parts.
- Lower jaw has two clamping surfaces to accommodate either thick or thin workpieces.
- The cam handle rotates to screw the lower jaw up or down for fine adjustment.

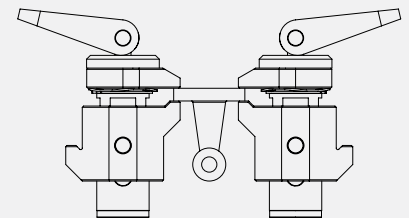
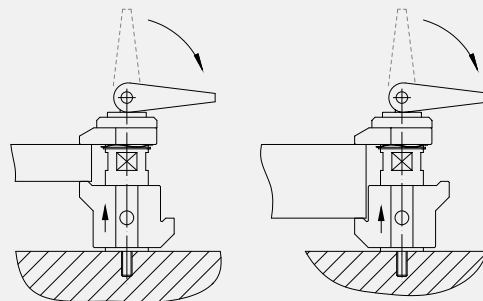
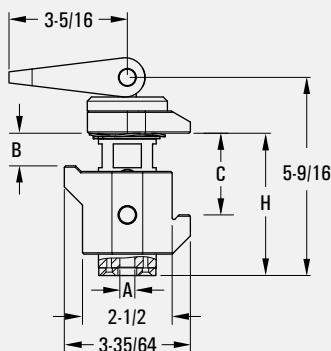
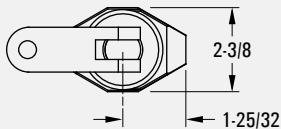

Upthrust Clamps locate off of the part's top surface and clamp up from below.

Part No.	H	A Thread	B Range		C Range		Max. Pressure (lbs.)
			Min	Max	Min	Max	
850250	100 mm $+0.000$ -0.025	1/2-13	0	1-3/8	1-3/8	2-3/4	2,200
850254	4 $+0.000$ -0.001						

Ball Crank Handles



Threaded

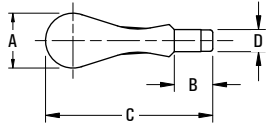

P/N	A	B	C	D
601015-B	.870	.43	2.68	5/16-18
601020-B	1.180	.71	3.89	7/16-14

Crank Handle

For Milling Machine

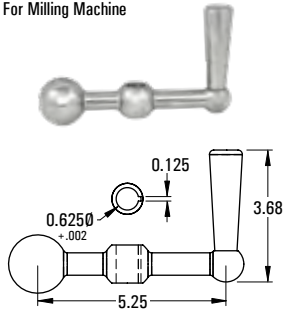

Part No. 601025-B

Quick Release Crank Handle

For Milling Machine

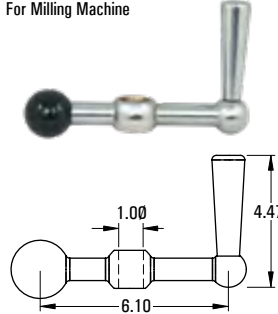

Part No. 601030-B

Knee Crank Handle

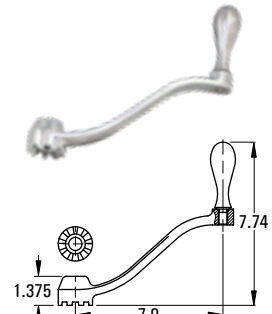

Part No. 601035-B

Crank Knob

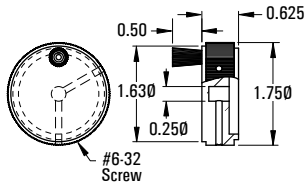

Part No. 601080-B

Table Stop Lock Handles

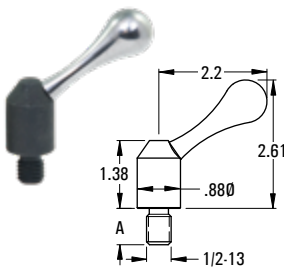

P/N	A
601045-B	.62
601050-B	.75

Quill Stop

For Milling Machine

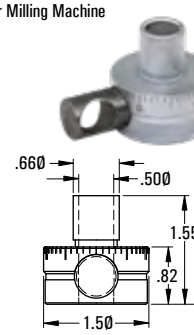

Part No. 601055-B

Dials

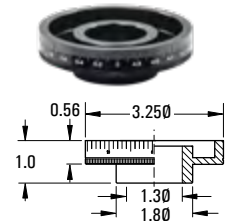

P/N	Description
601060-B	100 Graduation
601065-B	200 Graduation
601070-B	125 Graduation
601075-B	250 Graduation

6" Handwheel (Solid Handle)

For Grinding Machine



Part No. 601095-B

3" Handwheel

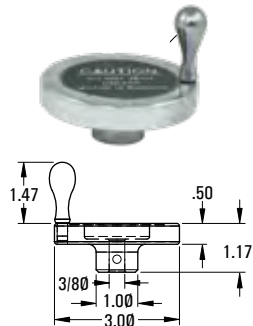

Part No. 601085-B

6" Handwheel

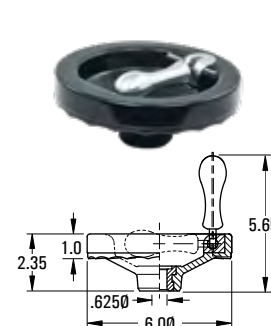

Part No. 601090-B

Vertical Handle
Hold Down Action

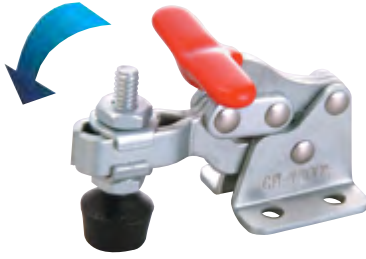

Horizontal Handle
Hold Down Action

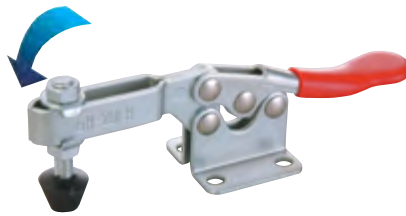

Push/Pull
Straight Line Action

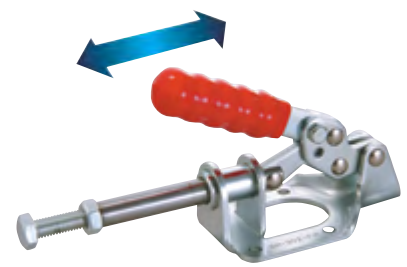

Latch Type
Pull Action

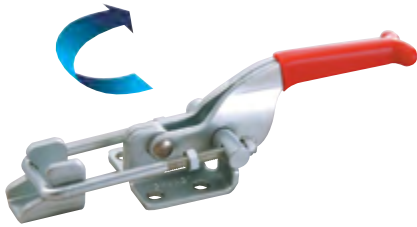

Cam Type
Hold Down Action

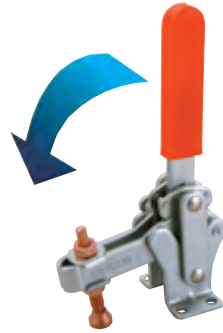

Toggle Pliers
Squeeze Action



F-Type
Pull Down Action



Pneumatic Power

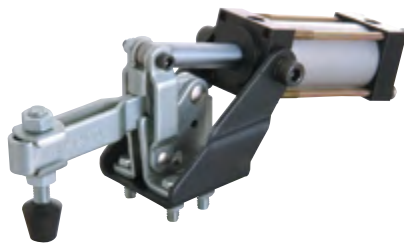

Yoke Assemblies



Heavy Duty Weldable
Hold Down Action



Contact us for complete catalog.

PRODUCT SAMPLER

Multi-functional Strong Hand Tools® Clamps, Magnets, and Pliers are Quick Acting, so you save time and money by completing work set-ups faster. Visit us online at www.stronghandtools.com and call 800.989.5244 to request the full line catalog.

Adjust-O Magnet Group & Other Innovative Magnets

The magnets with the ON/OFF switch - Fast, Easy, Convenient.



Adjust-O Magnet Squares
The Original ON/OFF Magnet



Adjust-O 90° Dual Switch Magnets
Heavy Duty 265 lb. Force



Mag-Level
Level with an ON/OFF Switch



MagTab™
Hold tabs parallel or perpendicular.
Adjusts for round, flat and angled.

Multi-Purpose Utility Clamps, Pliers & Vises



4-IN-1 Utility Clamps
4 functions in 1 clamp!
Standard, Pipe, Spreader, Step-Over



Round Tip Pliers
Improved Locking Mechanism



Pipe Pliers
The Easy Way to butt-weld pipes



3-Axis Fixture Vise
3-Axis Welding in One Setup

Welding Tables



Charge right through your next fab project!

The Rhino Cart Mobile Fixturing Station is a turnkey system for fixturing and clamping in welding and fabrication.

Clamp and fixture at any point on the reversible, flat, nitrided (heat treated) 30" x 48" tabletop for accuracy in all of your setups.

Table + Fixture Kit
ALL-IN-ONE
Mobility & Storage



Rhino Cart Mobile Fixturing Station
Mobile Welding Table + Fixturing Kit

Faster Fixturing. Consistent Results. Greater Productivity.

The affordable, professional BuildPro® Welding Tables are setting a new standard in price and performance.

The BuildPro's modular design gives you the flexibility to adapt to each new project easily. You'll work more safely and efficiently, so you can increase both your productivity and quality of work.

Precision, ground steel plates, with CNC machined $\text{Ø}5/8$ holes in a 2" grid pattern for locating, positioning and holding your fixture with the BuildPro® clamps and components.

Plates can be reconfigured to extend the width of the table for larger projects.

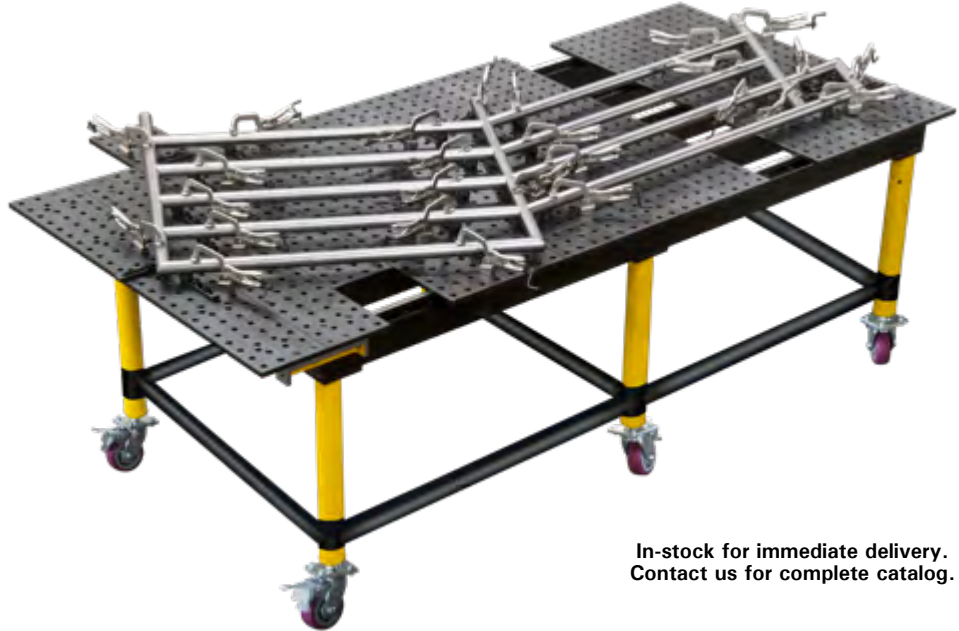

In-stock for immediate delivery. Contact us for complete catalog.

PRO28

28 mm Modular Fixturing System

Expand your capabilities in fixturing heavy duty, complex, or oversized weldments for precision welding and fabrication.

Individual positionable, reversible table plates

HV750 Tabletop Hardness
QPQ Nitriding Treatment

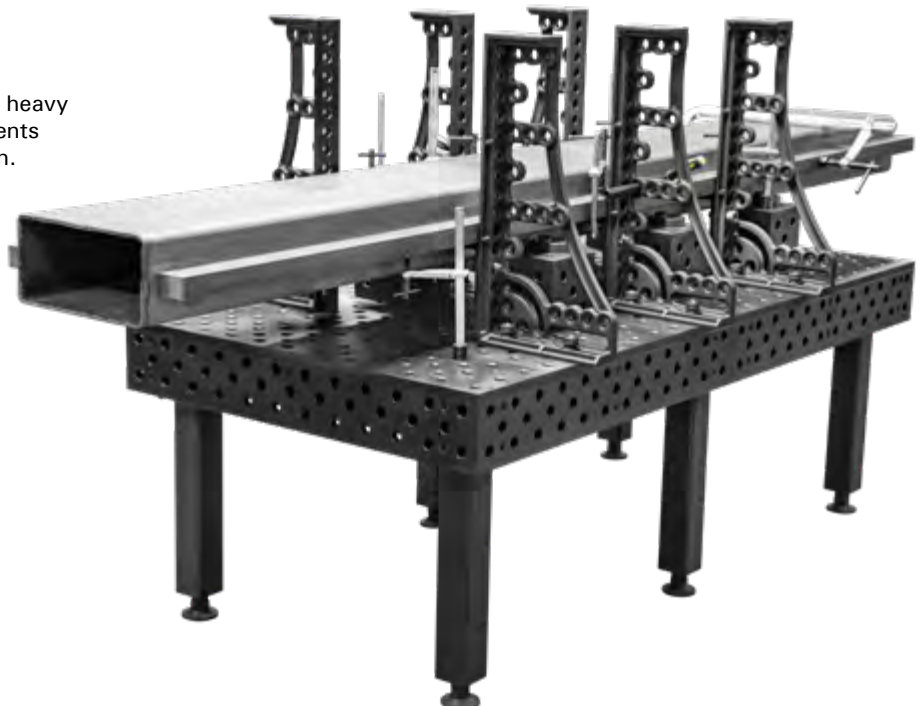

Authorized Distributor

Visit us online at:

www.stronghandtools.com

Customer Service

Toll Free: 800.989.5244

Tel: 562.949.8625

Fax: 562.949.4875

sales@stronghandtools.com

Address

8750 Pioneer Blvd,
Santa Fe Springs, CA 90670

© 2021